

# INSTRUCTION MANUAL

DC RECEIVING METER

XLC-110

HARDWARE MODEL A 【Without backlight】

XLC-110L

HARDWARE MODEL D 【White backlight】

Communication output

Thank you for purchasing DAIICHI ELECTRONICS product.  
Please read this instruction manual carefully before using.

## Safety precautions

### ■ Environment conditions

Please be sure to use this product in a place that meets the following conditions.

In places that do not meet this condition, it may cause malfunction or failure and product life decline.

- Within the range of ambient temperature -10 to +55 °C, humidity exceeding 85% RH.
- Place free of dust, corrosive gas, salt and oily smoke. (Corrosive gas : SO<sub>2</sub> / H<sub>2</sub>S, etc.)
- Location that is not affected by vibration and shock.
- Location that is not affected by external noise.
- Altitude 1000m or less.

### ■ Outdoor use conditions

- These products are not a dustproof, waterproof, and splash proof construction.

Please avoid the place with much dust. Moreover, please install in the place not exposed to rain or water drop.

- Please do not install in the place where sunlight hits directly.

Discoloration and degradation of a name plate, and deformation of the case by the surface temperature rise may occur.

### ■ Mounting and wiring

Please refer to this instruction manual for mounting and the wiring.

 CAUTION	<ul style="list-style-type: none"> <li>● Please refer to connection diagram for the wiring.</li> <li>● Please avoid hot line work.</li> <li>● Please use an electrical wire size suitable with the rated current.</li> <li>● Please check the tightening of the screw.</li> <li>● Please attach the terminal cover after work is completed</li> </ul>
---	---

### ■ Preparation

- When connecting this product directly to the main power supply, attach an appropriate fuse to the outside.
- This product must be set before use. Please set correctly after reading this instruction manual.

### ■ About use

Be careful with the following cautions during use.

- Use the input within the rated range.
- Close the switch cover when the unit is not operated.
- This product has a function to hold the maximum and minimum values depending on the measurement element. This value is guaranteed for power failure and is not cleared by a power reset. However, if no input is applied when the power is turned on, the minimum value may be updated. To keep the past minimum value when turning on the power, apply the input within 1 second after turning on the power.

 CAUTION	<ul style="list-style-type: none"> <li>● Be careful not to touch any terminal when power is applied to the unit.</li> <li>● Don't disassemble or modify this unit without any previous permission of our company. Modifications may cause troubles, a fire, or other accidents. For specifications change, etc., please contact us.</li> </ul>
---	--

### ■ Setting

This product requires setting and confirmation such as unit display before use. In the case of use in the initial setting, there is no need of setting and confirmation. If the setting is wrong, the measurement and output may not work properly. Read the instruction manual before setting.

### ■ About dew condensation

If the temperature and humidity of an installation change rapidly when a product is a non-energization, the waterdrop by dew condensation may adhere to a display inner side. (The display filter and the LCD surface stick and the pattern of the shape of a circle or an ellipse occur.)

This phenomenon does not cause any trouble. Disappears when control power is applied for 2 hours.

## ■ Maintenance and inspection

- Inspection in energized state is dangerous.
- Check that the measured values, scale, units, etc. are displayed correctly.
- Check that there is no discoloration of the LCD or damage to the case. Also check that there are no loose wiring or mounting screws.
- No replacement in periodic inspection.
- Please wipe off lightly with the dry soft cloth. Please do not use the organic solvent, chemicals, cleaners, etc., such as an alcohol, for cleaning.  
The LCD screen may light up during wiping, which is caused by static electricity on the filter.  
If left for a while, it will discharge naturally and return to its original state.  
Also, when pressing the filter, the filter may come into contact with the liquid crystal display surface, causing a round or elliptical pattern. Do not press the filter strongly.

## ■ Storage

Please store in a place that meets the following conditions.

- Within the range of ambient temperature -20 to +70 °C, humidity exceeding 5 to 90% RH.
- Daily average temperature 40 °C or less.
- Location corresponding to the usage environment and use conditions.
- Aluminum electrolytic capacitors are used in products. Please energize the power supply within one year after purchase.

## ■ Countermeasures against troubles

If trouble occurs within the warranty period, DAIICHI ELECTRONICS will repairs this product.

## ■ Disposal

Please dispose this product as industrial waste (non-combustible).

Mercury parts and a nickel-cadmium battery are not used for this product.

## ■ Warranty period

The warranty period of the product is one year after the date of delivery.

## ■ Warranty scope

In the state of the normal use of product-specification within the range according to this instruction manual, the trouble within the warranty period performs exchange or repair gratuitously.

However, the shipping expenses and the packing cost in the case of shipping obtain as payment on a customer.

And, if it corresponds to the next, it does not warrant.

- If it breaks down when converted or repaired except our company.
- Failures caused by violation of various conditions concerning use, storage, etc. specified by the Company.
- If the cause of trouble is based on cause other than this product.
- Transportation, movement, damage by falling, and trouble.
- Other cases where the supplier is not responsible, such as a natural disaster or disaster.

Only a product simplex is applied with a warranty. We cannot bear the responsibility such as the damage and the loss that occurred by the use of this product and trouble or the loss of profits.

And, a warranty is effective only in Japan.

## ■ Changes to the contents of the instruction manual

Please note that the contents of this instruction manual are subject to change without notice due to product improvements.

## Content

1. Instructions on the product	
1.1 Application	4
1.2 Features	4
2. Names and functions of component parts	5
3. Preparation	
3.1 Mounting	6
3.2 Connections	6
3.2.1 Connection diagram	6
3.2.2 Cautions on connections	7
4. Operation	7
5. Display	8
6. Setting	
6.1 Function table and default setting	10
6.2 Example of setting function	13
6.3 Setting table	15
6.4 Measurement display-mode in detail explanation	19
6.5 Setting detail explanatory	23
6.5.1 Setting mode 1	23
6.5.2 Setting mode 2	29
6.6 About the scale of bar graph	40
7. Specification	
7.1 Specification code, Type	41
7.2 Specification	42
7.3 Performance	44
7.4 Option specifications	46
8. Trouble shooting	46

Attached chart 1. Bar graph scale division details.

## 1. Instructions on the product

### 1.1 Application

In measurement of various physical quantities, although they are conversion and displayed on an electric signal, this product is used for the purpose of the display.

Three physical quantities can be displayed simultaneously. And the communication output of measurement data can be performed. The set monitor united with the system is made.

### 1.2 Features

- The simultaneous measurement display of dc-input 3 circuit is possible at one set.
- The withstand voltage between inputs is 2000V.
- This product has a scaling function that can set the full scale to any measurement value.
- 18 types of units can be set arbitrarily.
- Bar graph display (1 measurement) can be checked like meter.
- Upper limit and lower limit flicker setting is possible (with setting index).  
This index can also be used as a control index when the flickering function is turned off.
- The maximum and the minimum value of a measurement display can be held.
- Power supply is AC85V to 253V or DC80 to 143V (for both AC and DC uses). DC20 to 56V can also make.
- The mounting method of this unit is compatible with the mounting method of conventional 110 square mechanical meter. This unit is mounted at 2 diagonal points.
- With backlight function (XLC-110L)  
Always-on, Auto off (after 5 minutes without operating), Always-off and brightness setting is possible.  
LED: White

2. Names and functions of component parts

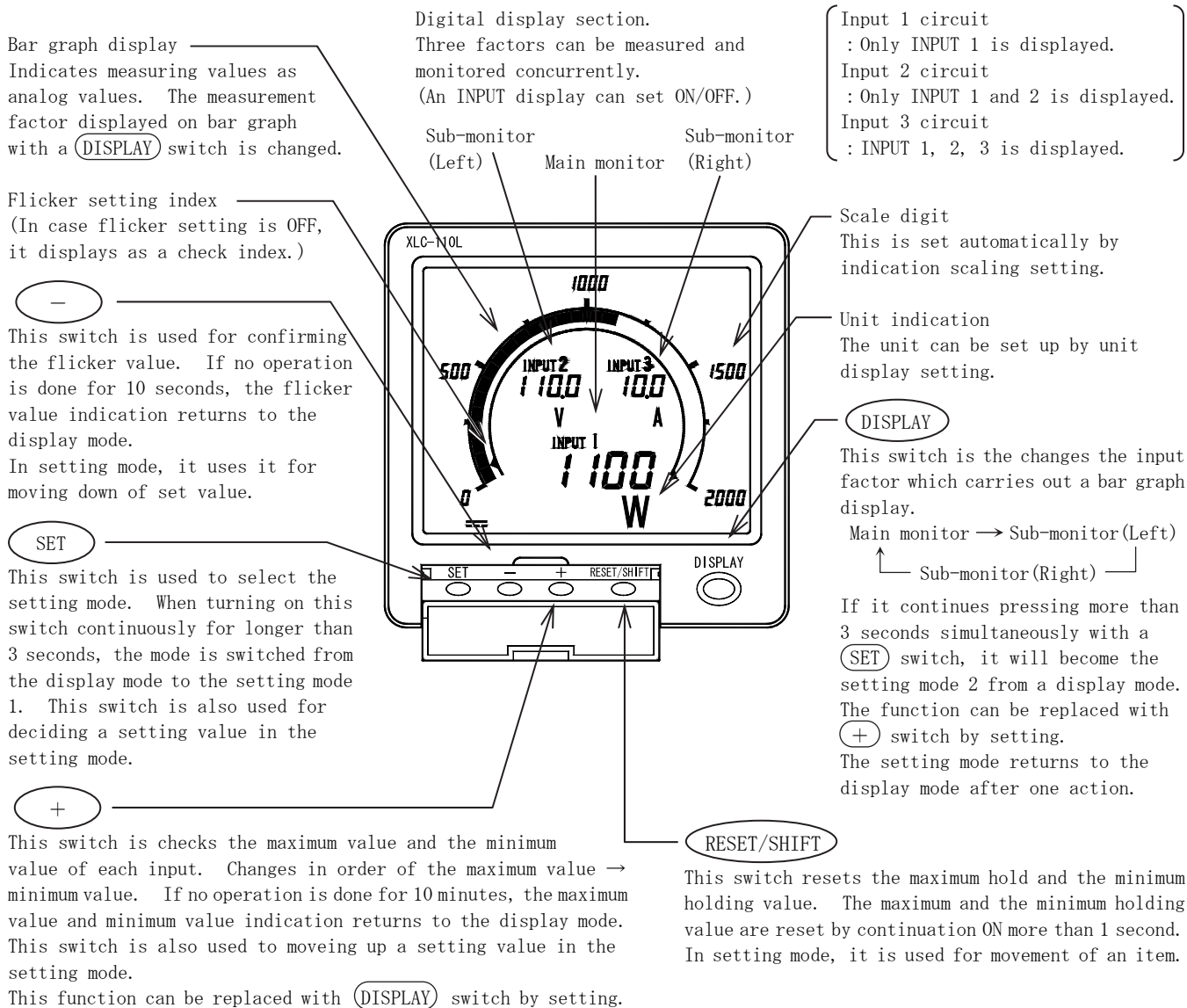

### 3. Preparation

#### 3.1 Mounting

Refer to the external dimensions and panel cut, and mount in the panel (with a thickness of 10 mm or less) with the M5 nut provided.

● Dimensions diagram

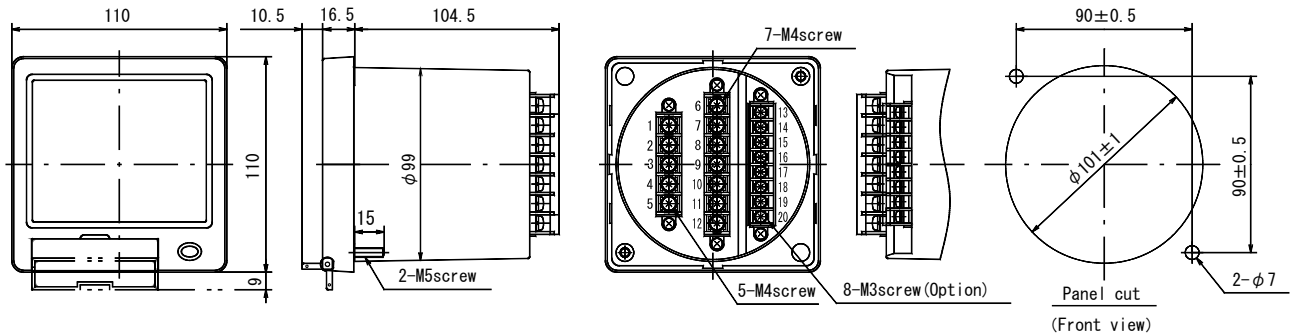

● LCD viewing angle

Mounting: Since the contrast of the LCD changes depending on the viewing angle, mount it at the optimal angle.

(1) Wide viewing angle model

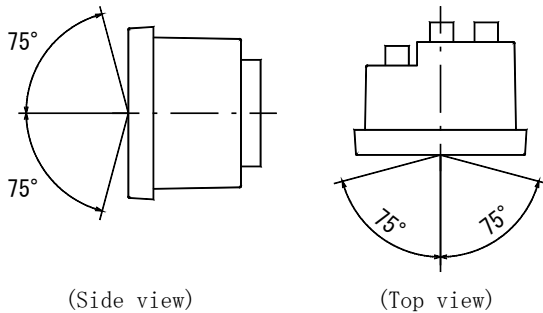

(2) For upper case installation

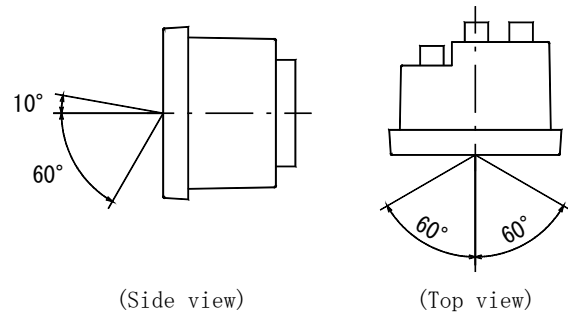

● Mounting

- (1) Insert the product into the cut hole of the panel from the front.
- (2) Secure the product with the mounting M5 flange nut (accessory).  
The tightening torque of the flange nut should be 2.0 to 2.5 N·m.

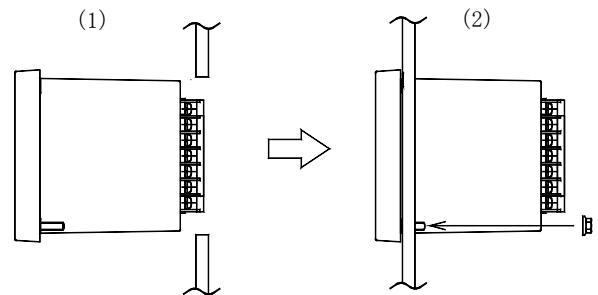

### 3.2 Connections

#### 3.2.1 Connection diagram

Input 1 circuit.

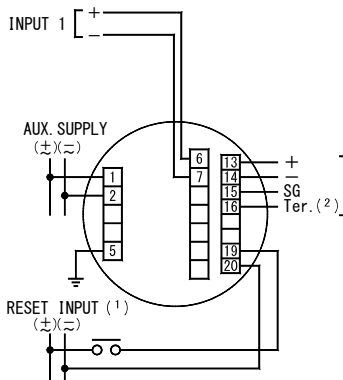

Input 2 circuit.

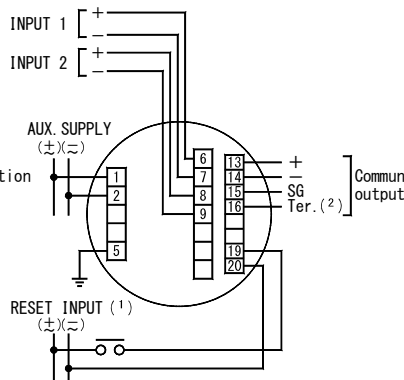

Input 3 circuit.

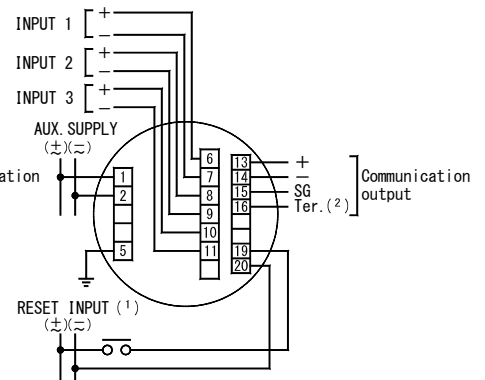

Note<sup>(1)</sup> Reset input is an option.

Note<sup>(2)</sup> A short circuit of No.14 and No.16 connects a termination register to an inside.

### 3.2.2 Cautions on connections

- (1) Mount the terminal cover without fail for safety after the end of connections.
- (2) Separate the input wiring and output wiring from each other without fail, and take a preventive measure against malfunction due to external noises.
- (3) Connect the grounding terminal E (No. 5 terminal) to the ground without fail for enhancing the shield effect keep the grounding resistance between the grounding terminal and the ground to be lower than 100Ω.
- (4) Keep a distance as much as possible of between this unit and the circuit breaker as well as between this unit and the relay contact signal line.
- (5) Please use a transmission line into a twisted-pair cable with a shield.  
And, please use as the same thing including the inside of a board.  
If there are many inductive noises, please be grounded in the most effective place (one point).

## 4. Operation

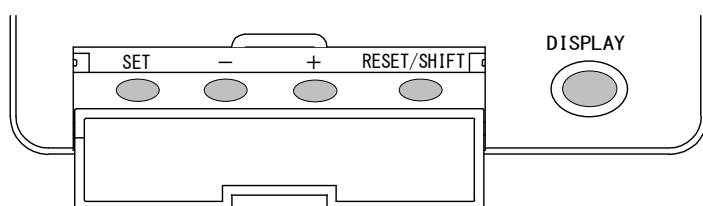

Switches	Functions
SET	By pressing this switch for longer than 3 seconds, the mode is switched from display mode to setting mode 1. By pressing this switch for longer than 3 seconds together with DISPLAY switch, the mode is switched from display mode to setting mode 2. This mode can be reset to the display mode by DISPLAY switch.
-	Flicker value can be checked. This mode can be reset to the display mode by DISPLAY switch.
+	Maximum value and minimum value can be checked. This function can be replaced with a DISPLAY switch.
RESET/SHIFT	By pressing this switch for longer than 1 seconds, reset of maximum and the minimum value can be performed.
DISPLAY	The input factor on which bar graph is displayed can be changed. Its function can be replaced with + switch.

#### ● Convenient functions

Even if the unit is stopped operating, it returns to the display mode in 10 minutes.



5. Display

(1) Example of display of input 1 circuit

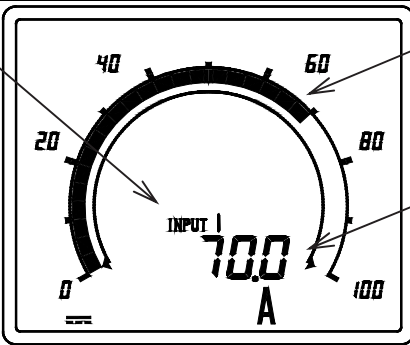
Display combination	Pattern 1 Main monitor : Input 1 (Set the INPUT display to ON.)
Display scaling	Input 1 : 0.0 to 100.0A
Display	<p><u>INPUT1</u> Measurement display symbol of input 1. During measurement, it always indicates. Indication off is possible by setting.</p>  <p><u>Bar graph display</u> [Main monitor] The measurement value of input 1 is indicated by the analog.</p> <p><u>Digital display</u> [Main monitor] The measurement value of input 1 is displayed.</p>

(2) Example of display of input 2 circuit

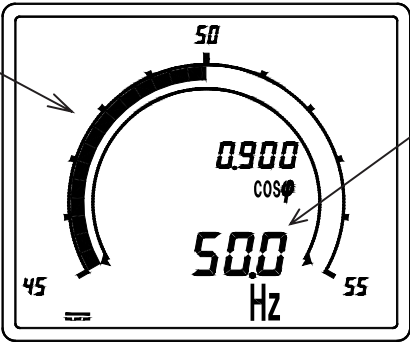
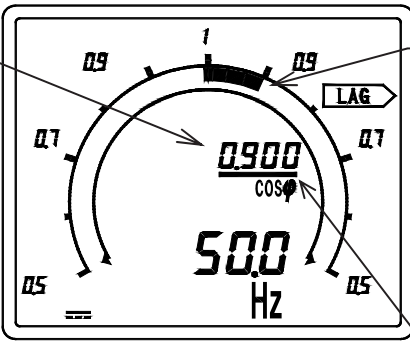
Display combination	Pattern 2 Main monitor : Input 1 , Sub-monitor (Right) : Input 2 (Set the INPUT display to auto off.)
Display scaling	Input 1 : 45.0 to 55.0Hz Input 2 : COS $\phi$ LEAD 0.500 to 1.000 to LAG 0.500
Display	<p>① Bar graph display of the main monitor.</p> <p><u>Bar graph display</u> [Main monitor] When it changes to "main monitor" with a <b>DISPLAY</b> switch, the measurement value of an input 1 is indicated by the analog.</p>  <p><u>Digital display</u> [Main monitor] The measurement value of input 1 is displayed. Frequency display : 3 digit (or 4 digit)</p> <p>Press <b>DISPLAY</b> switch</p> <p>② Bar graph display of the sub-monitor (right).</p> <p><u>Digital display</u> [Sub-monitor (right)] The measurement value of input 2 is displayed. Power factor display : 4 digit , position fixation of a decimal point.</p>  <p><u>Bar graph display</u> [Sub-monitor (right)] When it changes to "sub-monitor (right)" with a <b>DISPLAY</b> switch, the measurement value of an input 2 is indicated by the analog. An underbar indicates.</p> <p>The underbar of a sub-monitor (right) indicates.</p> <p><b>LEAD</b> or <b>LAG</b> indicates. It indicates, only if it changes to the input which is doing COS<math>\phi</math> display setting. It does not indicate, if it changes to other inputs.</p>

(3) Example of display of input 3 circuit

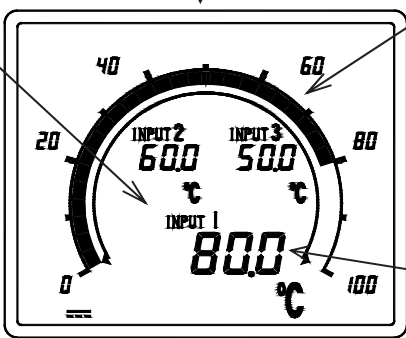
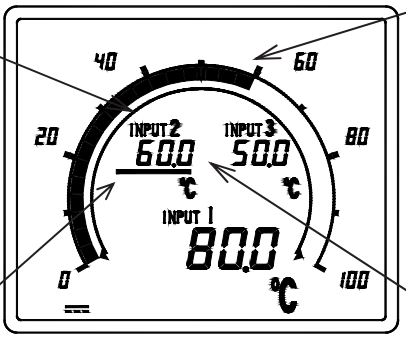
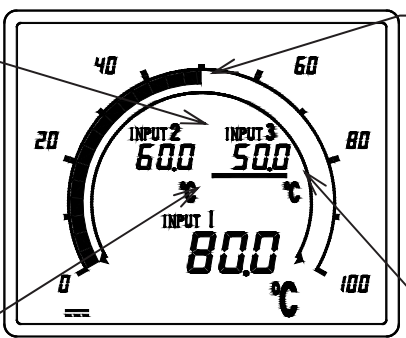
<p>Display combination</p>	<p>Pattern 1 Main monitor : Input 1 , Sub-monitor (Left) : Input 2 , sub-monitor (Right) : Input 3 (Set the INPUT display to ON.)</p>
<p>Display scaling</p>	<p>Input 1 : 0.0 to 100.0°C } If display scaling of 3 inputs is the same Input 2 : 0.0 to 100.0°C } Input 3 : 0.0 to 100.0°C }</p>
<p>Display</p>	<p>① Bar graph display of main monitor.</p> <div style="display: flex; justify-content: space-between;"> <div style="width: 45%;"> <p><u>INPUT 1</u></p> <p>Measurement display symbol of input 1. During measurement, it always indicates. Indication off is possible by setting.</p> </div> <div style="width: 45%; text-align: right;"> <p><u>Bar graph display</u> [Main monitor] When it changes to "main monitor" with a <span style="border: 1px solid black; padding: 2px;">DISPLAY</span> switch, the measurement value of an input 1 is indicated by the analog.</p> </div> </div>  <p style="text-align: center;">Press <span style="border: 1px solid black; padding: 2px;">DISPLAY</span> switch</p> <p>② Bar graph display of the sub-monitor (left).</p> <div style="display: flex; justify-content: space-between;"> <div style="width: 45%;"> <p><u>INPUT 2</u></p> <p>Measurement display symbol of input 2. During measurement, it always indicates. Indication off is possible by setting.</p> <p>The underbar of a sub-monitor (left) indicates.</p> </div> <div style="width: 45%; text-align: right;"> <p><u>Bar graph display</u> [Sub-monitor (left)] When it changes to "sub-monitor (left)" with a <span style="border: 1px solid black; padding: 2px;">DISPLAY</span> switch, the measurement value of an input 2 is indicated by the analog. An underbar indicates.</p> </div> </div>  <p style="text-align: center;">Press <span style="border: 1px solid black; padding: 2px;">DISPLAY</span> switch</p> <p>③ Bar graph display of the sub-monitor (right).</p> <div style="display: flex; justify-content: space-between;"> <div style="width: 45%;"> <p><u>INPUT 3</u></p> <p>Measurement display symbol of input 3. During measurement, it always indicates. Indication off is possible by setting.</p> <p>The underbar of a sub-monitor (right) indicates.</p> </div> <div style="width: 45%; text-align: right;"> <p><u>Bar graph display</u> [Sub-monitor (right)] When it changes to "sub-monitor (right)" with a <span style="border: 1px solid black; padding: 2px;">DISPLAY</span> switch, the measurement value of an input 3 is indicated by the analog. An underbar indicates.</p> </div> </div>  <p style="text-align: center;">Press <span style="border: 1px solid black; padding: 2px;">DISPLAY</span> switch</p> <p>* This is a limitation to the display pattern 1, and in order to check which input it is indicating, it is indicating "INPUT1", "INPUT2", and "INPUT3". However, Indication off is possible by setting.</p>

## 6. Setting

### 6.1 Function table and default setting

At the case of shipment, it is a following default setting. Please set up according to an operating condition. In addition, about setting products, it is shipped by the appointed set point.

Setting mode 1. Function table.

Setting No.	Function		Functional description	Default setting	Important setting	Page	
111	Display combination setting		Set the combination pattern of a digital display. By patterns 1 to 6, it can change arbitrarily the position of the digital display of a maximum of 3 circuits.	Pattern 1	○	24 25	
112	Unit display setting	Input 1	Set the unit display of an input 1.	With no unit display	○	24 25	
113		Input 2	Set the unit display of an input 2.	With no unit display	○		
114		Input 3	Set the unit display of an input 3.	With no unit display	○		
115	INPUT display ON/OFF		Set the ON/OFF of an INPUT display. However, only the pattern 1 of display combination is effective. OFF except for pattern 1.	ON	○	24 25	
121H	Input 1 Flicker setting	Upper limit value	The upper limit flicker value of an input 1 measurement display is set up.	100.0 (100% of display span)	○	26 27	
122L		Lower limit value	The lower limit flicker value of an input 1 measurement display is set up.	0.0 (0% of display span)	○		
123		ON/OFF	When input is more than detection or less than detection setting value, this sets flicker ON/OFF of digital display.	OFF	○		
124H	Input 2 Flicker setting	Upper limit value	The upper limit flicker value of an input 2 measurement display is set up.	100.0 (100% of display span)	○	26 27	
125L		Lower limit value	The lower limit flicker value of an input 2 measurement display is set up.	0.0 (0% of display span)	○		
126		ON/OFF	When input is more than detection or less than detection setting value, this sets flicker ON/OFF of digital display.	OFF	○		
127H	Input 3 Flicker setting	Upper limit value	The upper limit flicker value of an input 3 measurement display is set up.	100.0 (100% of display span)	○	26 27	
128L		Lower limit value	The lower limit flicker value of an input 3 measurement display is set up.	0.0 (0% of display span)	○		
129		ON/OFF	When input is more than detection or less than detection setting value, this sets flicker ON/OFF of digital display.	OFF	○		
131	DISPLAY switch function change setting		Set this function when changing the <input type="checkbox"/> switch and <input type="checkbox"/> DISPLAY switch.	0		27	
			0				<input type="checkbox"/> DISPLAY switch : Bar graph display change
							<input type="checkbox"/> + switch : Maximum and minimum value display change
			1				<input type="checkbox"/> DISPLAY switch : Maximum and minimum value display change
			<input type="checkbox"/> + switch : Bar graph display change				
151 ( <sup>3</sup> )	Backlight action		Set the backlight action from ON (always-on), AUTO (auto off), and OFF (always-off).	AUTO (Auto OFF)		28	
152 ( <sup>3</sup> )	Backlight brightness		Set the brightness of backlight.	3 (Middle)		28	

Note<sup>(3)</sup> This can set only at the case of white backlight specification.

Setting mode 2. Function table.

Setting No.	Function		Functional description	Default setting	Important setting	Page
211b	Input 1. Display scaling setting	BIAS	Display bias value setting of an input 1	0.0	○	30 31
212F		MAX.	Display max. value setting of an input 1	100.0	○	
213P		Decimal point	Decimal point setting of an input 1	□□□.□	○	
214		COS $\phi$ , Hz, var	COS $\phi$ , Hz, var display scaling setting of input 1	0 (Standard scale)	○	
215b	Input 2. Display scaling setting	BIAS	Display bias value setting of an input 2	0.0	○	30 31
216F		MAX.	Display max. value setting of an input 2	100.0	○	
217P		Decimal point	Decimal point setting of an input 2	□□□.□	○	
218		COS $\phi$ , Hz, var	COS $\phi$ , Hz, var display scaling setting of input 2	0 (Standard scale)	○	
219b	Input 3. Display scaling setting	BIAS	Display bias value setting of an input 3	0.0	○	30 31
21AF		MAX.	Display max. value setting of an input 3	100.0	○	
21bP		Decimal point	Decimal point setting of an input 3	□□□.□	○	
21C		COS $\phi$ , Hz, var	COS $\phi$ , Hz, var display scaling setting of input 3	0 (Standard scale)	○	
221b	Input 1. Input calibration	BIAS	Zero adjustment of the input 1 (INPUT1) at the case of a bias input can be performed. Display and output are adjusted simultaneously.	0.00		32
222F		SPAN	The input 1 display and output span adjustment at the case of an input apply can be performed. It is effective if a display wants to synchronize with other meter.	0.00		
223b	Input 2. Input calibration	BIAS	Zero adjustment of the input 2 (INPUT2) at the case of a bias input can be performed. Display and output are adjusted simultaneously.	0.00		32
224F		SPAN	The input 2 display and output span adjustment at the case of an input apply can be performed. It is effective if a display wants to synchronize with other meter.			
225b	Input 3. Input calibration	BIAS	Zero adjustment of the input 3 (INPUT3) at the case of a bias input can be performed. Display and output are adjusted simultaneously.	0.00		32
226F		SPAN	The input 3 display and output span adjustment at the case of an input apply can be performed. It is effective if a display wants to synchronize with other meter.	0.00		
231	Input sensitivity	Input 1	The full scale of input 1 bar graph display is changed.	100		33
232		Input 2	The full scale of input 2 bar graph display is changed.	100		
233		Input 3	The full scale of input 3 bar graph display is changed.	100		
241	Address setting		Set the address of communication output.	1	○	34 35
242	Transmission rate setting		Set the transmission rate of communication output.	9600bps	○	
243	Data length setting		Set the data length of communication data.	7 bit	○	
244	Parity setting		Set the parity bit of communication data.	Even number (E)	○	
245	Stop bit setting		Set the length of stop signal of communication data.	1 bit	○	
246	Checksum addition range setting		Set the addition range (ETX is included / ETX is not included) of checksum.	ETX is included	○	

Setting No.	Function		Functional description	Default setting	Important setting	Page
261	Low input cut	Input 1	In case of 0 to N, -N to 0 to N (example : -100 to 0 to 100) of display scaling.	OFF		36
262		Input 2	It does below 0.5% of inputs to 0 display. And, it makes communication output into a bias value.	OFF		
263		Input 3	-N' to 0 to N (example : -10 to 0 to 100) and -N to 0 do not function.	OFF		
271	Display dead band	Input 1	In case the input is unsteady, this setting can drop the sensitivity of a display.	0.0		37
272		Input 2		0.0		
273		Input 3		0.0		
281	Measurement display ON/OFF	Input 1	ON/OFF of an input 1 measurement display is set up.	ON		38
282		Input 2	ON/OFF of an input 2 measurement display is set up.	ON		
283		Input 3	ON/OFF of an input 3 measurement display is set up.	ON		
291	Returns to default setting		Initializes the all settings.	—		39

6.2 Example of setting function

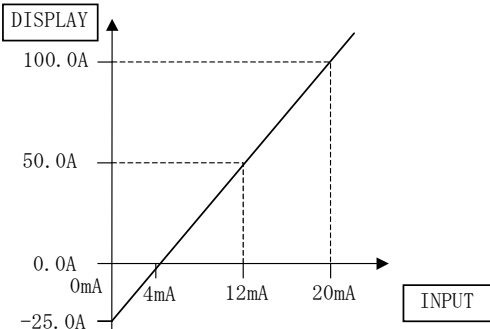
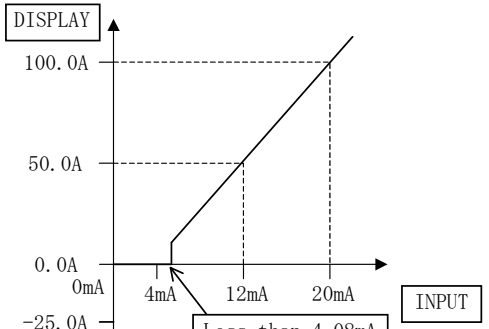
<p>Functional example ①</p>	<p>Input : 4 to 20mA, Display : 0.0 to 100.0A.                  In below 4mA of inputs, a display indicates the value (example. input 0mA → display : -25.0A) of minus. If you want to fix indicated value to 0 at the case of the below 4mA of inputs.</p>	
<p>Setting function</p>	<p>Please use "low input cut setting" (setting No.261 to 263) in the setting mode 2.                  → Indicated value is fixed to 0 at the case of the minute electric input equivalent to less than 0.5% of an input span.                  (Example. In case of 4 to 20mA, less than 4.08mA → display : 0.0A)                  However, effective only at the case of display scaling 0 to N and -N to 0 to N (example : -100 to 0 to 100). For -N' to 0 to N (example : -10 to 0 to 100) and -N to 0, this setting does not work.</p>	
<p>Function explanation</p>	<p style="text-align: center;">Before ( Setting : OFF )</p>  <p style="text-align: center;">Input : 4mA → Display : 0.0A                  Input : 0mA → Display : -25.0A</p>	<p style="text-align: center;">After ( Setting : ON )</p>  <p style="text-align: center;">Input : 4mA → Display : 0.0A                  Input : 0mA → Display : 0.0A</p>

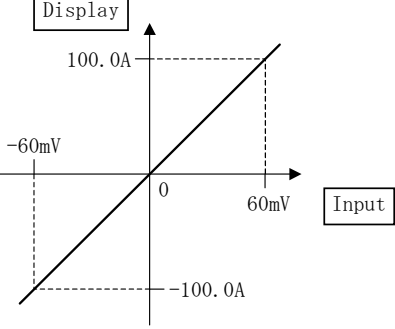
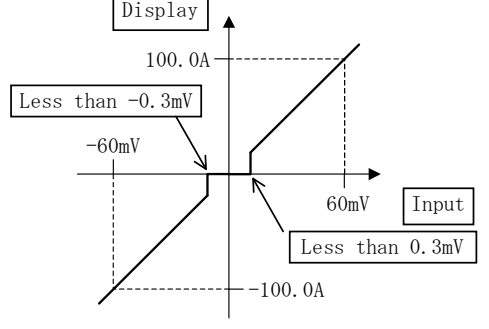
<p>Functional example ②</p>	<p>Input : ±60mV , Display : ±100.0A                  If you want to fix indicated value to 0 at the case of the minute electric input near 0mV of inputs.</p>	
<p>Setting function</p>	<p>Please use "low input cut setting" (setting No.261 to 263) in the setting mode 2.                  → Indicated value is fixed to 0 at the case of the minute electric input equivalent to less than 0.5% of an input span.                  (Example. In case of ±60mV, less than ±0.3mV → display : 0.0A)                  However, effective only at the case of display scaling 0 to N and -N to 0 to N (example : -100 to 0 to 100). For -N' to 0 to N (example : -10 to 0 to 100) and -N to 0, this setting does not work.</p>	
<p>Function explanation</p>	<p style="text-align: center;">Before ( Setting : OFF )</p>  <p style="text-align: center;">Input : 0.3mV → Display : 0.5A                  Input : 0mV → Display : 0.0A</p>	<p style="text-align: center;">After ( Setting : ON )</p>  <p style="text-align: center;">Input : Less than 0.3mV → Display : 0.0A                  Input : 0mV → Display : 0.0A</p>

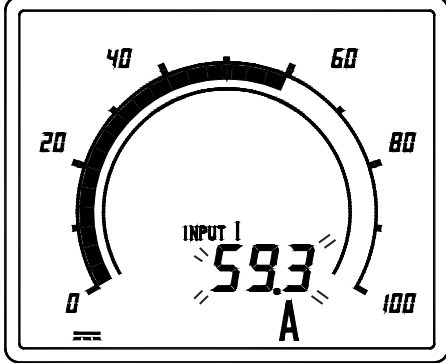
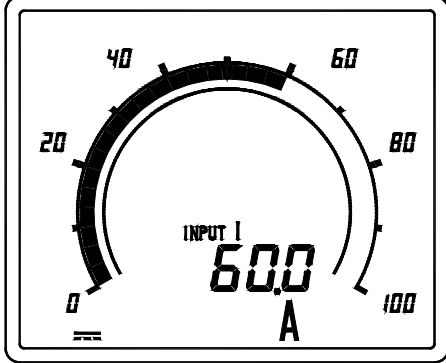
Functional example ③	Used to suppress the variation in the indicated value by input variation.	
Setting function	Please use "Display dead band setting" (setting No. 271 to 273) in the setting mode 2. → The sensitivity of a display is dropped and the variation in indicated value is suppressed. The setting range becomes 0.0% to 2.0% (0.1% step).	
Function explanation	Before ( Setting : 0.0% )	After ( Setting : 1.0% )
	 <p>Example) Near 60.0A, it varies from 59.3A to 60.8A</p>	 <p>Example) Variation is suppressed of near 60.0A.</p>

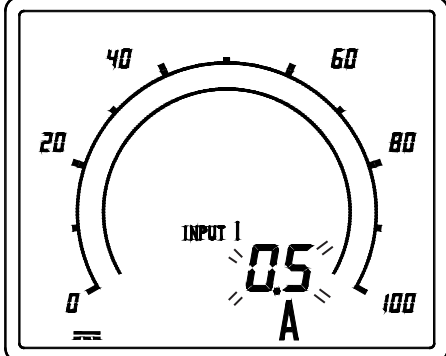
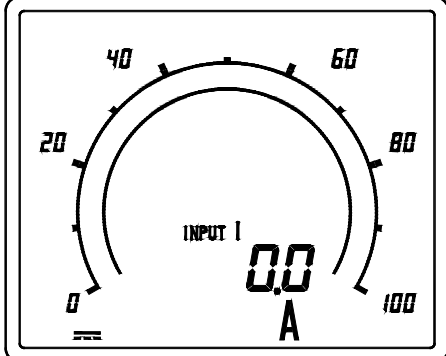
Functional example ④	In case the span or zero has shifted at the indicated value.	
Setting function	Please use "input calibration setting" (setting No. 221b to 226F) in the setting mode 2. → A span or zero is adjusted of indicated value. The setting range becomes -9.99% to 9.99% of an input span (0.01% step).	
Function explanation	Before ( Setting : BIAS 0.00%)	After ( Setting : BIAS -0.50%)
	 <p>Example) At the case of 4mA of inputs, it is displayed as place 0.5A whose indicated value is 0.0A.</p>	 <p>Example) At the case of 4mA of inputs, indicated value can be adjusted to 0.0A.</p>

### 6.3 Setting table

Each parenthesized number shows a setting number and this number is displayed on the setting screen.  
 <Caution> There is a setting item excepted by input circuits or measurement display ON/OFF setting.

(1) Setting of display combination and unit display.

Items	Setting and operation procedures	Page
Set the display combination. (111)	Press <b>SET</b> for longer than 3 seconds ➡ (111) Select the display combination pattern by <b>+</b> and <b>-</b> ➡ Press <b>SET</b> ➡ Selected display combination pattern is entered ➡ Press <b>DISPLAY</b> ➡ Returns to display mode	24, 25
Set the unit display of input 1 (112) ( <sup>4</sup> )	Press <b>SET</b> for longer than 3 seconds ➡ Press <b>RESET/SHIFT</b> ➡ (111) (112) Select the unit by <b>+</b> and <b>-</b> ➡ Press <b>SET</b> ➡ Selected unit is entered ➡ Press <b>DISPLAY</b> ➡ Returns to display mode	24, 25
Set the unit display of input 2 (113) ( <sup>4</sup> )	Press <b>SET</b> for longer than 3 seconds ➡ Press <b>RESET/SHIFT</b> ➡ (111) (112) Press <b>RESET/SHIFT</b> ➡ Select the unit by <b>+</b> and <b>-</b> ➡ Press <b>SET</b> ➡ (113) Selected unit is entered ➡ Press <b>DISPLAY</b> ➡ Returns to display mode	24, 25
Set the unit display of input 3 (114) ( <sup>4</sup> )	Press <b>SET</b> for longer than 3 seconds ➡ Press <b>RESET/SHIFT</b> ➡ (111) (112) Press <b>RESET/SHIFT</b> ➡ Press <b>RESET/SHIFT</b> ➡ Select the unit by <b>+</b> and <b>-</b> ➡ (113) (114) Press <b>SET</b> ➡ Selected unit is entered ➡ Press <b>DISPLAY</b> ➡ Returns to display mode	24, 25
Set the INPUT display ON/OFF (115) ( <sup>5</sup> )	Press <b>SET</b> for longer than 3 seconds ➡ Press <b>RESET/SHIFT</b> ➡ Press <b>RESET/SHIFT</b> ➡ (111) (112) ➡ Press <b>RESET/SHIFT</b> ➡ Press <b>RESET/SHIFT</b> ➡ (113) (114) (115) Select an INPUT display ON or OFF by <b>+</b> and <b>-</b> ➡ Press <b>SET</b> ➡ Selected ON/OFF setting is entered ➡ Press <b>DISPLAY</b> ➡ Returns to display mode	24, 25

Note(<sup>4</sup>) While doing COS<sup>φ</sup> and Hz and var display setting, there is a setting item excepted.

Note(<sup>5</sup>) Only the display combination pattern 1 is effective. Setting is excepted except pattern 1.



## (2) Flicker setting

Items	Setting and operation procedures	Page
Setting of upper limit flicker value of input 1. (121H)	Press <b>SET</b> for longer than 3 seconds ➡ Press <b>+</b> and <b>RESET/SHIFT</b> together ➡ (111) (121H) Select an upper limit flicker value by <b>+</b> and <b>-</b> ➡ Press <b>SET</b> ➡ Selected upper limit flicker value is entered ➡ Press <b>DISPLAY</b> ➡ Returns to display mode	26, 27
Setting of lower limit flicker value of input 1. (122L)	Press <b>SET</b> for longer than 3 seconds ➡ Press <b>+</b> and <b>RESET/SHIFT</b> together ➡ (111) (121H) Press <b>RESET/SHIFT</b> ➡ Select an lower limit flicker value by <b>+</b> and <b>-</b> ➡ (122L) Press <b>SET</b> ➡ Selected lower limit flicker value is entered ➡ Press <b>DISPLAY</b> ➡ Returns to display mode	26, 27
Setting of input 1 flicker ON/OFF. (123)	Press <b>SET</b> for longer than 3 seconds ➡ Press <b>+</b> and <b>RESET/SHIFT</b> together ➡ (111) (121H) Press <b>RESET/SHIFT</b> ➡ Press <b>RESET/SHIFT</b> ➡ (122L) (123) Select an flicker ON or flicker OFF by <b>+</b> and <b>-</b> ➡ Press <b>SET</b> ➡ Selected flicker ON/OFF setting is entered ➡ Press <b>DISPLAY</b> ➡ Returns to display mode	26, 27

(3) Functional exchange setting of **DISPLAY** and **+** switch.

Items	Setting and operation procedures	Page
Changes the function of <b>DISPLAY</b> switch and <b>+</b> switch. (131)	Press <b>SET</b> for longer than 3 seconds ➡ Press <b>+</b> and <b>RESET/SHIFT</b> together ➡ (111) (121H) Press <b>+</b> and <b>RESET/SHIFT</b> together ➡ Select an function by <b>+</b> and <b>-</b> ➡ (131) Press <b>SET</b> ➡ Selected function is entered ➡ Press <b>DISPLAY</b> ➡ Returns to display mode (Explanation) Display in setting 0: <b>DISPLAY</b> Bar graph display change. <b>+</b> Maximum value, minimum value display change. Display in setting 1: <b>DISPLAY</b> Maximum value, minimum value display change. <b>+</b> Bar graph display change.	27

## (4) Backlight setting

Items	Setting and operation procedures	Page
Setting of backlight action. (151)	Press <b>SET</b> for longer than 3 seconds ➡ Press <b>+</b> and <b>RESET/SHIFT</b> together ➡ (111) (121H) Press <b>+</b> and <b>RESET/SHIFT</b> together ➡ Press <b>+</b> and <b>RESET/SHIFT</b> together ➡ (131) (151) Select an backlight action by <b>+</b> and <b>-</b> ➡ Press <b>SET</b> ➡ Selected backlight action is entered ➡ Press <b>DISPLAY</b> ➡ Returns to display mode	28
Setting of backlight brightness. (152)	Press <b>SET</b> for longer than 3 seconds ➡ Press <b>+</b> and <b>RESET/SHIFT</b> together ➡ (111) (121H) Press <b>+</b> and <b>RESET/SHIFT</b> together ➡ Press <b>+</b> and <b>RESET/SHIFT</b> together ➡ (131) (151) Press <b>RESET/SHIFT</b> ➡ Select an backlight brightness by <b>+</b> and <b>-</b> ➡ Press <b>SET</b> ➡ (152) Selected backlight brightness is entered ➡ Press <b>DISPLAY</b> ➡ Returns to display mode	28

## (5) Display scaling setting

Items	Setting and operation procedures	Page
Setting of input 1 bias value. (211b) (6)	Press <b>SET</b> and <b>DISPLAY</b> together for longer than 3 seconds ➡ (211b) Setting an bias value by <b>+</b> and <b>-</b> ➡ Press <b>SET</b> ➡ Setting bias value is entered ➡ Press <b>DISPLAY</b> ➡ Returns to display mode	30, 31
Setting of input 1 max. value. (212F) (6)	Press <b>SET</b> and <b>DISPLAY</b> together for longer than 3 seconds ➡ (211b) Press <b>RESET/SHIFT</b> ➡ Setting an max. value by <b>+</b> and <b>-</b> ➡ Press <b>SET</b> ➡ (212F) Setting max. value is entered ➡ Press <b>DISPLAY</b> ➡ Returns to display mode	30, 31
Setting of input 1 decimal point position. (213P) (6)	Press <b>SET</b> and <b>DISPLAY</b> together for longer than 3 seconds ➡ Press <b>RESET/SHIFT</b> (211b) ➡ Press <b>RESET/SHIFT</b> ➡ Setting an decimal point position by <b>+</b> and <b>-</b> ➡ (212F) (213P) Press <b>SET</b> ➡ Setting decimal point position is entered ➡ Press <b>DISPLAY</b> ➡ Returns to display mode	30, 31
Setting of input 1 $\text{COS}\varphi$ , Hz, var. (214)	Press <b>SET</b> and <b>DISPLAY</b> together for longer than 3 seconds ➡ Press <b>RESET/SHIFT</b> (211b) ➡ Press <b>RESET/SHIFT</b> ➡ Press <b>RESET/SHIFT</b> ➡ (212F) (213P) (214) Select an $\text{COS}\varphi$ , Hz, var by <b>+</b> and <b>-</b> ➡ Press <b>SET</b> ➡ Selected $\text{COS}\varphi$ , Hz, var is entered ➡ Press <b>DISPLAY</b> ➡ Returns to display mode	30, 31

Note<sup>(6)</sup> The bias value and max. value and decimal point position setting (211b to 213P) of an input 1 is excepted, at the case of  $\text{COS}\varphi$ , Hz, var display (214) setting of input 1.

## (6) Communication output setting

Items	Setting and operation procedures	Page
Set the address. (241)	Press <b>SET</b> and <b>DISPLAY</b> together for longer than 3 seconds ➡ (211b) Press <b>+</b> and <b>RESET/SHIFT</b> together ➡ Press <b>+</b> and <b>RESET/SHIFT</b> together ➡ (221b) (231) Press <b>+</b> and <b>RESET/SHIFT</b> together ➡ Setting an address by <b>+</b> and <b>-</b> ➡ (241) Press <b>SET</b> ➡ Setting address is entered ➡ Press <b>DISPLAY</b> ➡ Returns to display mode	34, 35
Set the transmission rate. (242)	Press <b>SET</b> and <b>DISPLAY</b> together for longer than 3 seconds ➡ (211b) Press <b>+</b> and <b>RESET/SHIFT</b> together ➡ Press <b>+</b> and <b>RESET/SHIFT</b> together ➡ (221b) (231) Press <b>+</b> and <b>RESET/SHIFT</b> together ➡ Press <b>RESET/SHIFT</b> ➡ (241) (242) Setting an transmission rate by <b>+</b> and <b>-</b> ➡ Press <b>SET</b> ➡ Setting transmission rate is entered ➡ Press <b>DISPLAY</b> ➡ Returns to display mode	34, 35

Items	Setting and operation procedures	Page
Set the data length. (243)	Press <b>SET</b> and <b>DISPLAY</b> together for longer than 3 seconds ➡ (211b) Press <b>+</b> and <b>RESET/SHIFT</b> together ➡ Press <b>+</b> and <b>RESET/SHIFT</b> together ➡ (221b) (231) Press <b>+</b> and <b>RESET/SHIFT</b> together ➡ Press <b>RESET/SHIFT</b> ➡ (241) (242) Press <b>RESET/SHIFT</b> ➡ Setting an data length by <b>+</b> and <b>-</b> ➡ Press <b>SET</b> ➡ (243) Setting data length is entered ➡ Press <b>DISPLAY</b> ➡ Returns to display mode	34, 35
Set the parity bit. (244)	Press <b>SET</b> and <b>DISPLAY</b> together for longer than 3 seconds ➡ (211b) Press <b>+</b> and <b>RESET/SHIFT</b> together ➡ Press <b>+</b> and <b>RESET/SHIFT</b> together ➡ (221b) (231) Press <b>+</b> and <b>RESET/SHIFT</b> together ➡ Press <b>RESET/SHIFT</b> ➡ (241) (242) Press <b>RESET/SHIFT</b> ➡ Press <b>RESET/SHIFT</b> ➡ Setting an parity bit by <b>+</b> and <b>-</b> ➡ (243) (244) Press <b>SET</b> ➡ Setting parity bit is entered ➡ Press <b>DISPLAY</b> ➡ Returns to display mode	34, 35
Set the stop bit. (245)	Press <b>SET</b> and <b>DISPLAY</b> together for longer than 3 seconds ➡ (211b) Press <b>+</b> and <b>RESET/SHIFT</b> together ➡ Press <b>+</b> and <b>RESET/SHIFT</b> together ➡ (221b) (231) Press <b>+</b> and <b>RESET/SHIFT</b> together ➡ Press <b>RESET/SHIFT</b> ➡ (241) (242) Press <b>RESET/SHIFT</b> ➡ Press <b>RESET/SHIFT</b> ➡ Press <b>RESET/SHIFT</b> ➡ (243) (244) (245) Setting an stop bit by <b>+</b> and <b>-</b> ➡ Press <b>SET</b> ➡ Setting stop bit is entered ➡ Press <b>DISPLAY</b> ➡ Returns to display mode	34, 35
Set the checksum addition range. (246)	Press <b>SET</b> and <b>DISPLAY</b> together for longer than 3 seconds ➡ (211b) Press <b>+</b> and <b>RESET/SHIFT</b> together ➡ Press <b>+</b> and <b>RESET/SHIFT</b> together ➡ (221b) (231) Press <b>+</b> and <b>RESET/SHIFT</b> together ➡ Press <b>RESET/SHIFT</b> ➡ Press <b>RESET/SHIFT</b> ➡ (241) (242) (243) Press <b>RESET/SHIFT</b> ➡ Press <b>RESET/SHIFT</b> ➡ Press <b>RESET/SHIFT</b> ➡ (244) (245) (246) Select an including ETX or not including ETX of checksum addition range by <b>+</b> and <b>-</b> . ➡ Press <b>SET</b> ➡ Setting checksum addition range is entered ➡ Press <b>DISPLAY</b> ➡ Returns to display mode	34, 35

### 6.4 Measurement display-mode in detail explanation

■ If a power supply is put into this product, it will become a measurement display mode.

Digital-display section

[Main monitor, Sub-monitor (left), Sub-monitor (right)]

The measurement display of three factors can be performed simultaneously.

[If display position is changed. To the setting mode 1.]

• Input 2 (INPUT2), input 3 (INPUT3), are different by the number of input circuits.

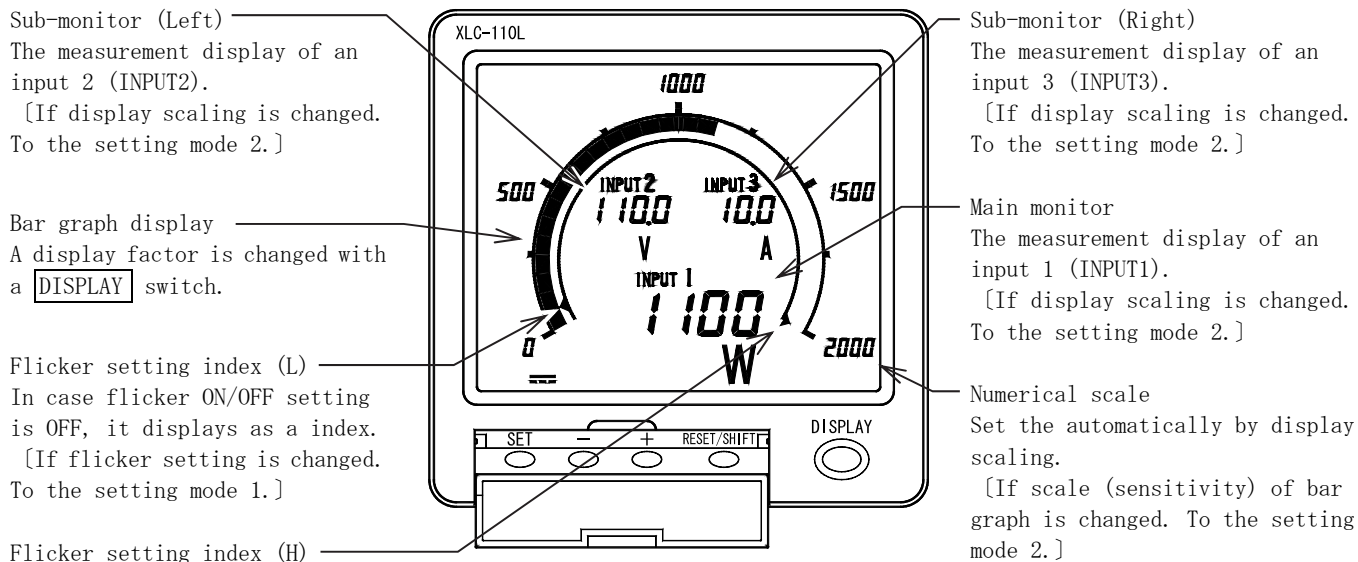

■ Switch operation from a measurement display mode.

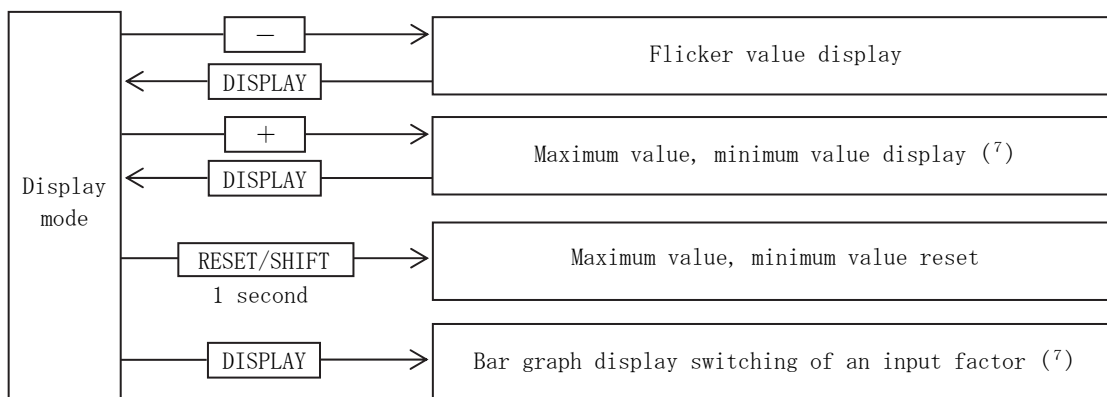

Note(7) If it is made the next setting by "DISPLAY switch-function exchange setting" and DISPLAY is pressed, the maximum value and the minimum value will indicate.

[+]: Bar graph display change. [DISPLAY]: Maximum value, minimum value display change.

- By continuing pressing a SET switch for 3 seconds, it becomes the setting mode 1. ⇒ 23 pages
- Press and hold the SET switch and DISPLAY switch at the same time for 3 seconds or more to enter setting mode 2. ⇒ 29 pages

<Caution> There is a display item excepted by the number of input circuits or measurement display ON/OFF setting.

- In case of input 1 circuit specification, there is no display item of input 2 and input 3.
- In case of input 2 circuit specification, there is no display item of input 3.
- Please keep in mind that not all measurement values display in case a measurement display is OFF altogether.

Operation from a measurement display mode

(1) Flicker value display

The check of the flicker value of an input factor can be performed.

<p>Display</p>	
<p>Operation</p>	<p>Whenever press the <input type="checkbox"/> switch from a display mode, it indicates the upper limit and lower limit flicker value of an input factor.</p>
<p>Reset method</p>	<p>Press the <input type="checkbox"/> DISPLAY switch or returns to a measurement display mode by no operating it for 10 seconds.</p>
<p>Display screen</p>	<div style="display: flex; justify-content: space-around;"> <div style="text-align: center;"> <p>·The upper limit flicker-value display of an input 1.</p> <p>Upper limit. Setting index.</p> <p>Input factor. Upper limit flicker value.</p> </div> <div style="text-align: center;"> <p>·The lower limit flicker-value display of an input 1.</p> <p>Setting index. Lower limit.</p> <p>Lower limit flicker value.</p> </div> <div style="text-align: center;"> <p>·The display in the state where the flicker was exceeded.</p> <p>Setting index is not displayed.</p> <p>OFF : When a flicker value is exceeded.</p> </div> </div>

(2) Maximum value, minimum value display

The check of the maximum value and minimum value of an input factor can be performed.  
The value is held even if maximum value and the minimum value turn off a power supply.

<p>Display</p>	
<p>Operation</p>	<p>Whenever it presses <input type="checkbox"/> switch from a display mode, the maximum and the minimum value of an input factor are displayed. It judges value with a value including polarity, for the maximum value and minimum value. Example) In -10.0A and 5.0A, the maximum value is set to 5.0A and the minimum value is set to -10.0A.</p> <p>Note<sup>(8)</sup> If it is made the next setting by "DISPLAY switch-function exchange setting" and <input type="checkbox"/> is pressed, the maximum value and the minimum value will indicate. <input type="checkbox"/> : Bar graph display change. <input type="checkbox"/> : Maximum value, minimum value display change.</p>
<p>Reset method</p>	<p>Presses the <input type="checkbox"/> switch or returns to a measurement display mode by no operating it for 10 minutes.</p>
<p>Display screen</p>	<p>•Maximum value display of input 1    •Minimum value display of input 1</p> <div style="display: flex; justify-content: space-around;"> <div style="text-align: center;"> <p>Maximum value display [最大]</p> <p>Maximum value</p> </div> <div style="text-align: center;"> <p>Minimum value display [最小]</p> <p>Minimum value</p> </div> </div> <p>The maximum and the minimum are displayed in Japanese. <input type="checkbox"/> : Maximum <input type="checkbox"/> : Minimum</p>

(3) Maximum and minimum value reset.

The maximum and the minimum holding value of an input factor are reset.

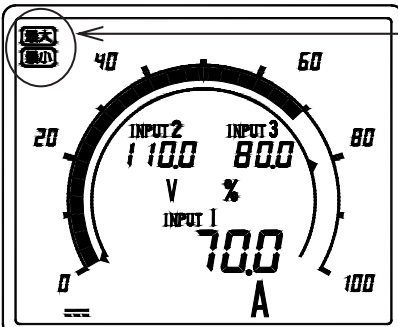
Reset process	<div style="display: flex; align-items: center; gap: 10px;"> <div style="border: 1px solid black; padding: 5px; width: 60px; text-align: center;">Display mode</div> <div style="text-align: center;">             RESET/SHIFT              Pushes more than              1 second.         </div> <div style="border: 1px solid black; padding: 5px; width: 200px; text-align: center;">             Maximum value and minimum value              reset of all input factors         </div> </div>
Reset method	During a display mode or maximum and minimum value display, a <span style="border: 1px solid black; padding: 2px;">RESET/SHIFT</span> switch is pressed for the more than 1 seconds. The maximum and the minimum holding value of all input factors are reset.
After reset	Maximum value and minimum value are in agreement with the present input value after reset.
Screen display (Pattern 1)	<p>• Maximum value and minimum value reset display</p> <div style="display: flex; align-items: center;">  <div style="margin-left: 20px;"> <p>A <span style="border: 1px solid black; padding: 2px;">RESET/SHIFT</span> switch is pressed more than 1 second. Flashing the <span style="border: 1px solid black; padding: 2px;">最大</span> (maximum) and <span style="border: 1px solid black; padding: 2px;">最小</span> (minimum) for 3 seconds simultaneously.</p> <p>The maximum and the minimum are displayed in Japanese.</p> <p><span style="border: 1px solid black; padding: 2px;">最大</span> : Maximum  <span style="border: 1px solid black; padding: 2px;">最小</span> : Minimum</p> </div> </div>

(4) Bar graph display change

The input factor that carries out a bar graph display can be changed.

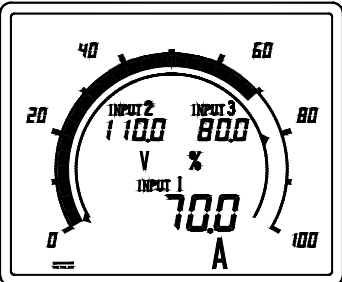
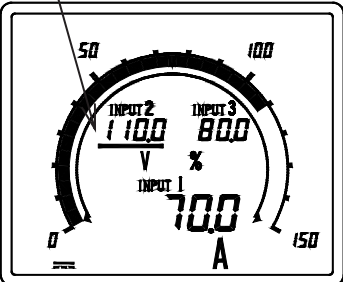
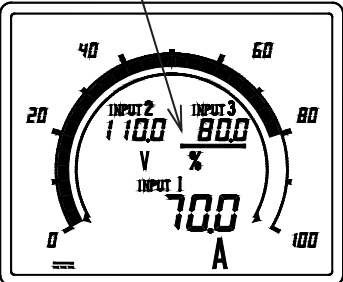
Display change process	<div style="border: 1px dashed black; padding: 10px; text-align: center;"> <p>(<sup>9</sup>)</p> <p>DISPLAY</p> <div style="display: flex; justify-content: space-around; align-items: center;"> <div style="border: 1px solid black; padding: 5px;">Bar graph display of main monitor</div> <div style="text-align: center;">(<sup>9</sup>) DISPLAY</div> <div style="border: 1px solid black; padding: 5px;">Bar graph display of sub-monitor (left)</div> <div style="text-align: center;">(<sup>9</sup>) DISPLAY</div> <div style="border: 1px solid black; padding: 5px;">Bar graph display of sub-monitor (right)</div> </div> </div>		
Display change method	<p>Whenever press the <span style="border: 1px solid black; padding: 2px;">DISPLAY</span> switch in a display mode, the bar graphical representation of an input factor changes.</p> <p>Note(<sup>9</sup>) If it is made the next setting by "<span style="border: 1px solid black; padding: 2px;">DISPLAY</span> switch-function exchange setting" and <span style="border: 1px solid black; padding: 2px;">+</span> is pressed, the bar graphical representation of an input factor changes.</p> <p><span style="border: 1px solid black; padding: 2px;">+</span> : Bar graph display change. <span style="border: 1px solid black; padding: 2px;">DISPLAY</span> : Maximum value, minimum value display change.</p>		
Screen display (Pattern 1)	<p>• Bar graph display of main monitor</p> 	<p>• Bar graph display of sub-monitor (left)</p> <p>Underbar lighting of a sub-monitor (left)</p> 	<p>• Bar graph display of sub-monitor (right)</p> <p>Underbar lighting of a sub-monitor (right)</p> 

## 6.5 Setting detail explanatory

### 6.5.1 Setting mode 1

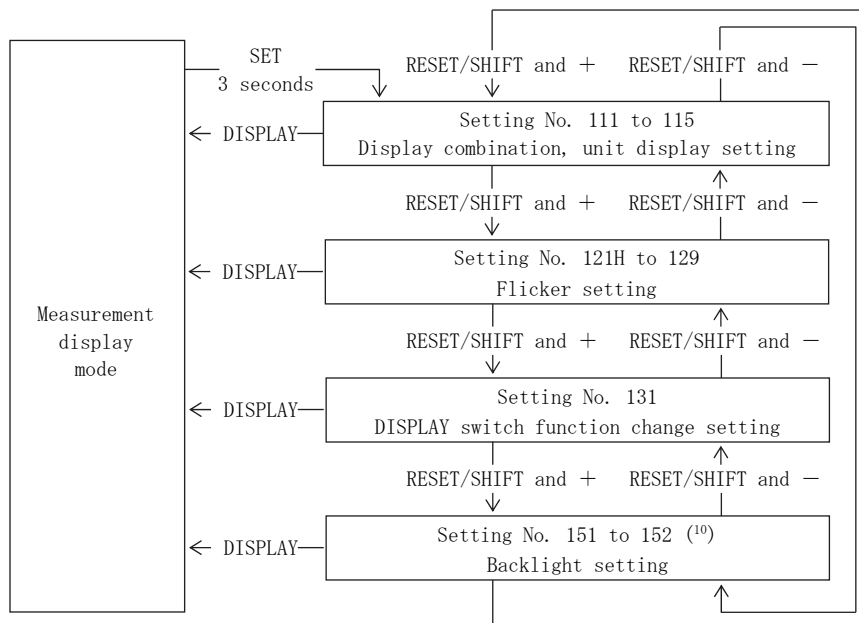

If a **SET** switch is pressed for by continuation more than 3 seconds, it will become the setting mode 1 from a display mode.

It moves a setting item with **RESET/SHIFT** and **+** switch (or **RESET/SHIFT** and **-** switch).

If a **DISPLAY** switch is pressed, it will return to a display mode.

If **+** and **-** switches are pressed together for longer than 3 seconds during setting, the present set values only are reset to the default settings.

<Caution> There is a display item excepted by the number of input circuits or measurement display ON/OFF setting.

- In case of input 1 circuit specification, there is no display item of input 2 and input 3.
- In case of input 2 circuit specification, there is no display item of input 3.
- Please keep in mind that not all measurement values display in case a measurement display is OFF altogether.

Note<sup>(10)</sup> Only white backlight specifications can be set.



(1) Display combination, Unit display setting (Setting No. 111 to 115)

Display combination and unit display of input element can be set.  
And, it can perform setting which erases a display of INPUT.

<p>Setting process</p>	<p>Please refer to a display combination list for details.</p> <p>The setting range of a unit display changes with display combination (111). Please refer to a unit display list for details.</p> <p>Pattern 1 only</p> <p>Default setting</p>																							
<p>Setting item</p>	<table border="1"> <thead> <tr> <th>Setting No.</th> <th>Contents of setting</th> <th>Setting value possible range</th> </tr> </thead> <tbody> <tr> <td>111</td> <td>Display combination setting</td> <td>Pattern 1 to 6</td> </tr> <tr> <td rowspan="2">112</td> <td rowspan="2">Unit display setting of an input 1.</td> <td>Pattern 1, 2</td> </tr> <tr> <td>Pattern 3 to 6</td> </tr> <tr> <td rowspan="2">113</td> <td rowspan="2">Unit display setting of an input 2.</td> <td>Pattern 3, 4</td> </tr> <tr> <td>Pattern 1, 2, 5, 6</td> </tr> <tr> <td rowspan="2">114</td> <td rowspan="2">Unit display setting of an input 3.</td> <td>Pattern 5, 6</td> </tr> <tr> <td>Pattern 1 to 4</td> </tr> <tr> <td>115</td> <td>INPUT display ON/OFF setting</td> <td>ON/OFF</td> </tr> </tbody> </table>	Setting No.	Contents of setting	Setting value possible range	111	Display combination setting	Pattern 1 to 6	112	Unit display setting of an input 1.	Pattern 1, 2	Pattern 3 to 6	113	Unit display setting of an input 2.	Pattern 3, 4	Pattern 1, 2, 5, 6	114	Unit display setting of an input 3.	Pattern 5, 6	Pattern 1 to 4	115	INPUT display ON/OFF setting	ON/OFF		
Setting No.	Contents of setting	Setting value possible range																						
111	Display combination setting	Pattern 1 to 6																						
112	Unit display setting of an input 1.	Pattern 1, 2																						
		Pattern 3 to 6																						
113	Unit display setting of an input 2.	Pattern 3, 4																						
		Pattern 1, 2, 5, 6																						
114	Unit display setting of an input 3.	Pattern 5, 6																						
		Pattern 1 to 4																						
115	INPUT display ON/OFF setting	ON/OFF																						
<p>Setting method</p>	<p>Setting display</p>	<p>Setting mode 1 is selected by pressing <b>SET</b> switch for longer than 3 seconds. For shifting to the item of display combination setting and unit display setting, press <b>+</b> and <b>RESET/SHIFT</b> or <b>-</b> and <b>RESET/SHIFT</b> together. Whenever it presses <b>RESET/SHIFT</b> switch, setting item changes. Only the pattern 1 of INPUT display ON/OFF setting is effective. Setting is excepted except pattern 1. By display scaling setting in the setting mode 2, unit display setting (112 to 114) of an input factor which is doing COS<math>\phi</math> (and Hz, and var) display setting is excepted.</p> <p>Setting value change</p> <p>If a <b>+</b> switch or <b>-</b> switch is pressed, the set value will change.</p> <p>Update of setting value</p> <p>If a <b>SET</b> switch is pressed, the set point will update.</p> <p>Return to default setting</p> <p>If <b>+</b> and <b>-</b> switches are pressed together for longer than 3 seconds during setting, the current set values only are reset to the default setting values.</p>																						
<p>Reset method</p>	<p>Press the <b>DISPLAY</b> switch or returns to a measurement display mode by no operating it for 10 minutes.</p>																							

• Display combination setting  
In the case of a pattern 1.

Setting No.      Current setting

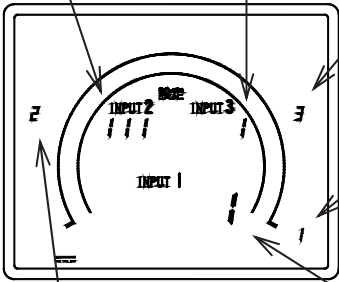

Indicates an input 2 on a sub-monitor (left).  
Indicates an input 3 on a sub-monitor (right).  
Indicates an input 1 on the main monitor.

New setting

In the case of a pattern 5.

Setting No.      Current setting

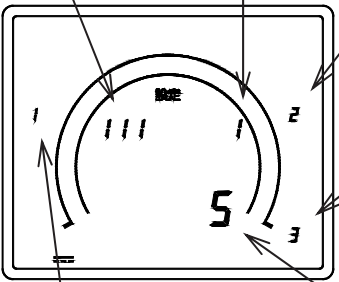

Indicates an input 1 on a sub-monitor (left).  
Indicates an input 2 on a sub-monitor (right).  
Indicates an input 3 on the main monitor.

New setting

• Unit display setting of input 1 (Pattern 1)

Setting No.      New setting      Current setting

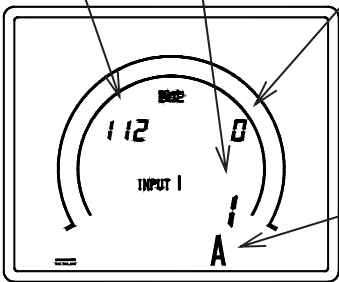

Unit display

• INPUT display ON/OFF setting (Pattern 1)

Setting No.      New setting      Current setting

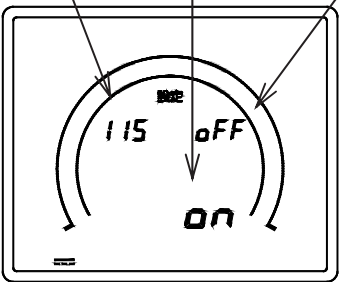

Display-position change is attained with display combination.  
Pattern 1 : Standard product , Pattern 2 to 6 : At the case of display-position designating.

Pattern No.	1 input specification			2 input specification			3 input specification			INPUT display
	Main monitor	Sub monitor (left)	Sub monitor (right)	Main monitor	Sub monitor (left)	Sub monitor (right)	Main monitor	Sub monitor (left)	Sub monitor (right)	
Pattern 1	INPUT 1	—	—	INPUT 1	INPUT 2	—	INPUT 1	INPUT 2	INPUT 3	ON/OFF
Pattern 2				INPUT 1	—	INPUT 2	INPUT 1	INPUT 3	INPUT 2	OFF
Pattern 3				INPUT 2	INPUT 1	—	INPUT 2	INPUT 1	INPUT 3	OFF
Pattern 4				INPUT 2	—	INPUT 1	INPUT 2	INPUT 3	INPUT 1	OFF
Pattern 5				—	INPUT 1	INPUT 2	INPUT 3	INPUT 1	INPUT 2	OFF
Pattern 6				—	INPUT 2	INPUT 1	INPUT 3	INPUT 2	INPUT 1	OFF

With display combination, the setting range of a unit display of an input factor changes.

Unit display No.	INPUT 1		INPUT 2		INPUT 3	
	Pattern 1, 2	Pattern 3 to 6	Pattern 3, 4	Pattern 1, 2, 5, 6	Pattern 5, 6	Pattern 1 to 4
0	Not display	Not display	Not display	Not display	Not display	Not display
1	A	A	A	A	A	A
2	kA	kA	kA	kA	kA	kA
3	V	V	V	V	V	V
4	kV	kV	kV	kV	kV	kV
5	W	°C	W	°C	W	°C
6	kW	%	kW	%	kW	%
7	MW	m	MW	m	MW	m
8	°C	m <sup>3</sup>	°C	m <sup>3</sup>	°C	m <sup>3</sup>
9	%	m <sup>3</sup> /h	%	m <sup>3</sup> /h	%	m <sup>3</sup> /h
10	m	m <sup>3</sup> /min	m	m <sup>3</sup> /min	m	m <sup>3</sup> /min
11	m <sup>3</sup>	r/min	m <sup>3</sup>	r/min	m <sup>3</sup>	r/min
12	m <sup>3</sup> /h	min	m <sup>3</sup> /h	min	m <sup>3</sup> /h	min
13	m <sup>3</sup> /min	—	m <sup>3</sup> /min	—	m <sup>3</sup> /min	—
14	m/h	—	m/h	—	m/h	—
15	m/min	—	m/min	—	m/min	—
16	r/min	—	r/min	—	r/min	—
17	min	—	min	—	min	—

(2) Flicker setting (Setting No. 121H to 129)

The upper limit and low limit setting of the flicker of an input factor, and ON/OFF setting can be performed. However, setting of an upper limit value and a lower limit value turns into setting in the range of an upper limit value > lower limit value.

<p>Setting process</p>																																
<p>Setting item</p>	<table border="1"> <thead> <tr> <th>Setting No.</th> <th>Contents of a setting</th> <th>Setting value possible range</th> </tr> </thead> <tbody> <tr> <td>121H</td> <td>Upper limit flicker setting of input 1</td> <td>-20% to 120% of display span. OFF <sup>(1)</sup></td> </tr> <tr> <td>122L</td> <td>Lower limit flicker setting of input 1</td> <td>-20% to 120% of display span. OFF <sup>(1)</sup></td> </tr> <tr> <td>123</td> <td>Flicker ON/OFF setting of input 1</td> <td>ON/OFF</td> </tr> <tr> <td>124H</td> <td>Upper limit flicker setting of input 2</td> <td>-20% to 120% of display span. OFF <sup>(1)</sup></td> </tr> <tr> <td>125L</td> <td>Lower limit flicker setting of input 2</td> <td>-20% to 120% of display span. OFF <sup>(1)</sup></td> </tr> <tr> <td>126</td> <td>Flicker ON/OFF setting of input 2</td> <td>ON/OFF</td> </tr> <tr> <td>127H</td> <td>Upper limit flicker setting of input 3</td> <td>-20% to 120% of display span. OFF <sup>(1)</sup></td> </tr> <tr> <td>128L</td> <td>Lower limit flicker setting of input 3</td> <td>-20% to 120% of display span. OFF <sup>(1)</sup></td> </tr> <tr> <td>129</td> <td>Flicker ON/OFF setting of input 3</td> <td>ON/OFF</td> </tr> </tbody> </table>	Setting No.	Contents of a setting	Setting value possible range	121H	Upper limit flicker setting of input 1	-20% to 120% of display span. OFF <sup>(1)</sup>	122L	Lower limit flicker setting of input 1	-20% to 120% of display span. OFF <sup>(1)</sup>	123	Flicker ON/OFF setting of input 1	ON/OFF	124H	Upper limit flicker setting of input 2	-20% to 120% of display span. OFF <sup>(1)</sup>	125L	Lower limit flicker setting of input 2	-20% to 120% of display span. OFF <sup>(1)</sup>	126	Flicker ON/OFF setting of input 2	ON/OFF	127H	Upper limit flicker setting of input 3	-20% to 120% of display span. OFF <sup>(1)</sup>	128L	Lower limit flicker setting of input 3	-20% to 120% of display span. OFF <sup>(1)</sup>	129	Flicker ON/OFF setting of input 3	ON/OFF	
Setting No.	Contents of a setting	Setting value possible range																														
121H	Upper limit flicker setting of input 1	-20% to 120% of display span. OFF <sup>(1)</sup>																														
122L	Lower limit flicker setting of input 1	-20% to 120% of display span. OFF <sup>(1)</sup>																														
123	Flicker ON/OFF setting of input 1	ON/OFF																														
124H	Upper limit flicker setting of input 2	-20% to 120% of display span. OFF <sup>(1)</sup>																														
125L	Lower limit flicker setting of input 2	-20% to 120% of display span. OFF <sup>(1)</sup>																														
126	Flicker ON/OFF setting of input 2	ON/OFF																														
127H	Upper limit flicker setting of input 3	-20% to 120% of display span. OFF <sup>(1)</sup>																														
128L	Lower limit flicker setting of input 3	-20% to 120% of display span. OFF <sup>(1)</sup>																														
129	Flicker ON/OFF setting of input 3	ON/OFF																														
<p>Setting method</p>	<p>Setting display</p> <p>Setting mode 1 is selected by pressing <b>SET</b> switch for longer than 3 seconds. For shifting to the item of flicker setting, press <b>+</b> and <b>RESET/SHIFT</b> or <b>-</b> and <b>RESET/SHIFT</b> together. Whenever it presses <b>RESET/SHIFT</b> switch, setting item changes.</p> <p>Setting value change</p> <p>If a <b>+</b> switch or <b>-</b> switch is pressed, the set value will change. The set point can change in high-speed operation gradually by continuing pressing <b>+</b> or <b>-</b> switch. A detecting function will be excepted if it is made setting which exceeds 120% by upper limit flicker setting. (OFF, ▲ disappears.) A detecting function will be excepted if it is made setting which exceeds -20% by lower limit flicker setting. (OFF, ▲ disappears.)</p> <p>Note<sup>(1)</sup> Set value possible range when doing COS<math>\phi</math> display setting, 0% to 100% and OFF of display span.</p> <p>Update of setting value</p> <p>If a <b>SET</b> switch is pressed, the set point will update.</p> <p>Return to default setting</p> <p>If <b>+</b> and <b>-</b> switches are pressed together for longer than 3 seconds during setting, the current set values only are reset to the default setting values. However, both an upper limit flicker value and a lower limit flicker value return to a default setting.</p>																															
<p>Reset method</p>	<p>Press the <b>DISPLAY</b> switch or returns to a measurement display mode by no operating it for 10 minutes.</p>																															

Display	<ul style="list-style-type: none"> <li>•Upper limit flicker value setting of input 1.</li> </ul> <p>Setting No.    Current setting</p> <p>New setting    Setting index</p>	<ul style="list-style-type: none"> <li>•Lower limit flicker value setting of input 1.</li> </ul> <p>Setting No.    Current setting</p> <p>Setting index    New setting</p>	<ul style="list-style-type: none"> <li>•Flicker ON/OFF setting of input 1.</li> </ul> <p>Setting No.    Current setting</p> <p>New setting</p>
---------	--	--	--

(3) **DISPLAY** switch function change setting (Setting No. No. 131)

The function of **DISPLAY** switch and **+** switch can be replaced.

Setting process	<p>Setting No. 131</p>		
Setting item	Setting No.	Contents of setting	Setting value possible range
	131	Function exchange of <b>DISPLAY</b> switch and <b>+</b> switch	0, 1
Setting method	Setting display	Setting mode 1 is selected by pressing <b>SET</b> switch for longer than 3 seconds. For shifting to the item of <b>DISPLAY</b> switch-function exchange setting, press <b>+</b> and <b>RESET/SHIFT</b> or <b>-</b> and <b>RESET/SHIFT</b> together.	
	Setting value change	If a <b>+</b> switch or <b>-</b> switch is pressed, the set value will change.	
	Update of setting value	If a <b>SET</b> switch is pressed, the set point will update.	
	Return to default setting	If <b>+</b> and <b>-</b> switches are pressed together for longer than 3 seconds during setting, the current set values only are reset to the default setting values.	
Reset method	Press the <b>DISPLAY</b> switch or returns to a measurement display mode by no operating it for 10 minutes.		
Display	<ul style="list-style-type: none"> <li>• <b>DISPLAY</b> switch-function exchange setting</li> </ul> <p>Setting No.    Current setting</p> <p>The setting are displayed in Japanese. 設定 : Setting</p> <p>New setting</p>		

(4) Backlight setting (Setting No. 151 to 152) 【White backlight only】

Set the action and brightness of backlight. The backlight setting is only white backlight products.

Setting process		<p>◆ 151 Backlight action The operation of the backlight can be selected from ON (always on), AUTO (auto off), and OFF (always off). If 5 minutes elapses without operating a switch in case it is set as "AUTO (auto off)", backlight is automatically off. After that, backlight will be turned on if either of switches is operated. Selection by <b>[+]</b> and <b>[-]</b>, set value is updated by <b>[SET]</b>.</p> <p>◆ 152 Backlight brightness The backlight brightness can be selected from 5 levels from 1 to 5. Backlight becomes the darkest if it is set as "1". Backlight becomes the brightest if it is set as "5". Selection by <b>[+]</b> and <b>[-]</b>, set value is updated by <b>[SET]</b>.</p> <table border="1" style="margin-left: auto; margin-right: auto; border-collapse: collapse; text-align: center;"> <thead> <tr> <th style="padding: 2px;">Setting value</th> <th style="padding: 2px;">Brightness</th> </tr> </thead> <tbody> <tr> <td style="padding: 2px;">5</td> <td rowspan="5" style="padding: 2px; vertical-align: middle;">                     Bright                      ↑                      ↓                      Dark                 </td> </tr> <tr> <td style="padding: 2px;">4</td> </tr> <tr> <td style="padding: 2px;">3</td> </tr> <tr> <td style="padding: 2px;">2</td> </tr> <tr> <td style="padding: 2px;">1</td> </tr> </tbody> </table>	Setting value	Brightness	5	Bright ↑ ↓ Dark	4	3	2	1	
Setting value	Brightness										
5	Bright ↑ ↓ Dark										
4											
3											
2											
1											
Setting item	<table border="1" style="width: 100%; border-collapse: collapse;"> <thead> <tr> <th style="width: 15%;">Setting No.</th> <th style="width: 35%;">Contents of setting</th> <th style="width: 50%;">Setting value possible range</th> </tr> </thead> <tbody> <tr> <td style="text-align: center;">151</td> <td>Backlight action</td> <td>AUTO (Auto OFF), OFF (always-off), ON (always-on)</td> </tr> <tr> <td style="text-align: center;">152</td> <td>Backlight brightness</td> <td>1, 2, 3, 4, 5</td> </tr> </tbody> </table>	Setting No.	Contents of setting	Setting value possible range	151	Backlight action	AUTO (Auto OFF), OFF (always-off), ON (always-on)	152	Backlight brightness	1, 2, 3, 4, 5	
Setting No.	Contents of setting	Setting value possible range									
151	Backlight action	AUTO (Auto OFF), OFF (always-off), ON (always-on)									
152	Backlight brightness	1, 2, 3, 4, 5									
Setting method	<table border="1" style="width: 100%; border-collapse: collapse;"> <tr> <td style="width: 20%;">Setting display</td> <td>Setting mode 1 is selected by pressing <b>[SET]</b> switch for longer than 3 seconds. For shifting to the item of backlight setting, press <b>[+]</b> and <b>[RESET/SHIFT]</b> or <b>[-]</b> and <b>[RESET/SHIFT]</b> together.</td> </tr> <tr> <td>Setting value change</td> <td>If a <b>[+]</b> switch or <b>[-]</b> switch is pressed, the set value will change.</td> </tr> <tr> <td>Update of setting value</td> <td>If a <b>[SET]</b> switch is pressed, the set point will update.</td> </tr> <tr> <td>Return to default setting</td> <td>If <b>[+]</b> and <b>[-]</b> switches are pressed together for longer than 3 seconds during setting, the current set values only are reset to the default setting values.</td> </tr> </table>	Setting display	Setting mode 1 is selected by pressing <b>[SET]</b> switch for longer than 3 seconds. For shifting to the item of backlight setting, press <b>[+]</b> and <b>[RESET/SHIFT]</b> or <b>[-]</b> and <b>[RESET/SHIFT]</b> together.	Setting value change	If a <b>[+]</b> switch or <b>[-]</b> switch is pressed, the set value will change.	Update of setting value	If a <b>[SET]</b> switch is pressed, the set point will update.	Return to default setting	If <b>[+]</b> and <b>[-]</b> switches are pressed together for longer than 3 seconds during setting, the current set values only are reset to the default setting values.		
Setting display	Setting mode 1 is selected by pressing <b>[SET]</b> switch for longer than 3 seconds. For shifting to the item of backlight setting, press <b>[+]</b> and <b>[RESET/SHIFT]</b> or <b>[-]</b> and <b>[RESET/SHIFT]</b> together.										
Setting value change	If a <b>[+]</b> switch or <b>[-]</b> switch is pressed, the set value will change.										
Update of setting value	If a <b>[SET]</b> switch is pressed, the set point will update.										
Return to default setting	If <b>[+]</b> and <b>[-]</b> switches are pressed together for longer than 3 seconds during setting, the current set values only are reset to the default setting values.										
Reset method	Press the <b>[DISPLAY]</b> switch or returns to a measurement display mode by no operating it for 10 minutes.										
Display	<p>• Backlight action setting</p>										

## 6.5.2 Setting mode 2

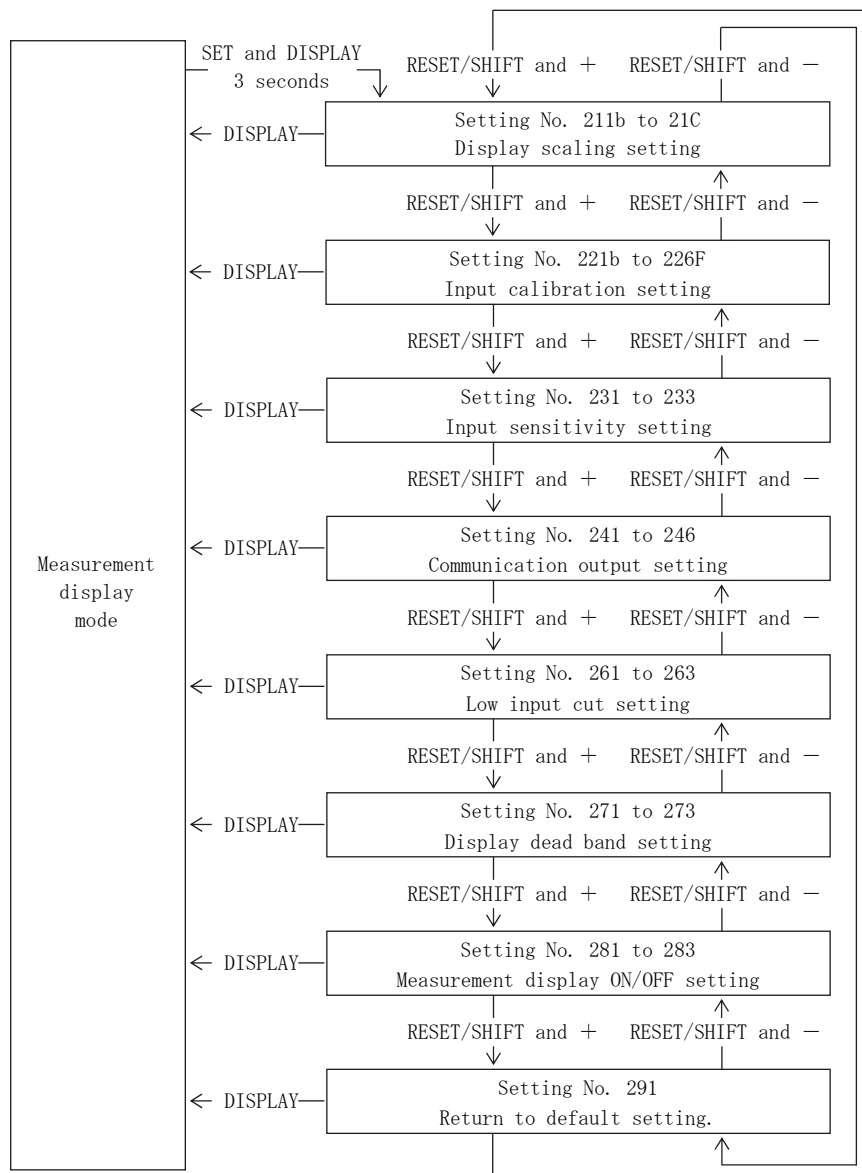

If **SET** switch and **DISPLAY** switch are pressed together for longer than 3 seconds, it becomes the setting mode 2 from measurement display mode.

It moves a setting item with **RESET/SHIFT** and **+** switch (or **RESET/SHIFT** and **-** switch).

If a **DISPLAY** switch is pressed, it will return to a display mode.

If **+** and **-** switches are pressed together for longer than 3 seconds during setting, the current set values only are reset to the default settings.

<Caution> There is a display item excepted by the number of input circuits or measurement display ON/OFF setting.



- In case of input 1 circuit specification, there is no display item of input 2 and input 3.
  - In case of input 2 circuit specification, there is no display item of input 3.
  - In the case where a measurement display is OFF altogether, the next setting is possible.
- Setting mode 2, "Returns to a default setting", "Measurement display ON/OFF setting".

(1) Display scaling setting (Setting No. 211b to 21C)

Scaling setting of the indicated value of an input factor can be performed.

However, setting of an bias value and max. value turns into setting in the range of an bias value < max. value.

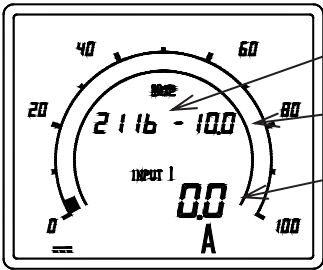
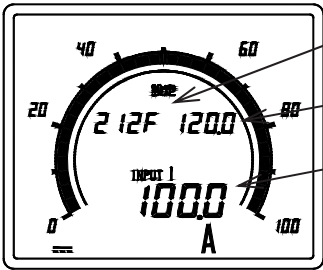
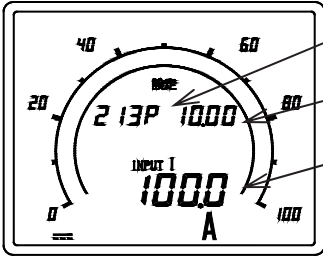
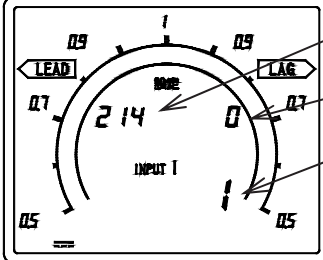
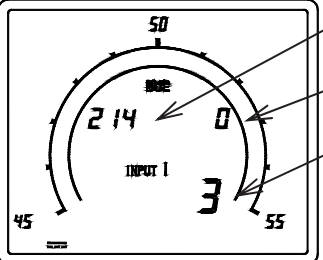
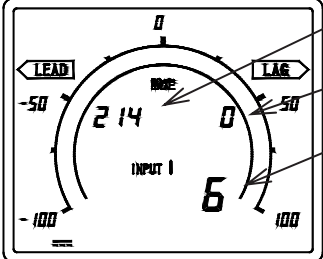
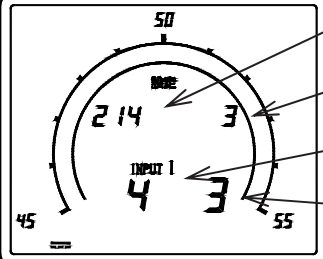
<p>Setting process</p>																																															
<p>Setting item</p>	<table border="1"> <thead> <tr> <th>Setting No.</th> <th>Contents of setting</th> <th>Setting value possible range</th> </tr> </thead> <tbody> <tr> <td>211b</td> <td>Display bias value setting of input 1</td> <td>-9999 to 9998 (var : LEAD 9999 to 1)</td> </tr> <tr> <td>212F</td> <td>Display max. value setting of input 1</td> <td>-9998 to 9999 (var : LAG 1 to 9999)</td> </tr> <tr> <td>213P</td> <td>Display decimal point setting of input 1</td> <td>No decimal point to 3 digits decimal point</td> </tr> <tr> <td rowspan="3">214</td> <td rowspan="3">COSφ, Hz, var display setting of input 1</td> <td>COSφ : 0.5 to 1 to 0.5 , 0 to 1 to 0</td> </tr> <tr> <td>Hz : 45 to 55Hz , 55 to 65Hz , 45 to 65Hz</td> </tr> <tr> <td>Var : LEAD □ to 0 to LAG □ (Set the □ in 211b to 213P)</td> </tr> <tr> <td>215b</td> <td>Display bias value setting of input 2</td> <td>-9999 to 9998 (var : LEAD 9999 to 1)</td> </tr> <tr> <td>216F</td> <td>Display max. value setting of input 2</td> <td>-9998 to 9999 (var : LAG 1 to 9999)</td> </tr> <tr> <td>217P</td> <td>Display decimal point setting of input 2</td> <td>No decimal point to 3 digits decimal point</td> </tr> <tr> <td rowspan="3">218</td> <td rowspan="3">COSφ, Hz, var display setting of input 2</td> <td>COSφ : 0.5 to 1 to 0.5 , 0 to 1 to 0</td> </tr> <tr> <td>Hz : 45 to 55Hz , 55 to 65Hz , 45 to 65Hz</td> </tr> <tr> <td>Var : LEAD □ to 0 to LAG □ (Set the □ in 215b to 217P)</td> </tr> <tr> <td>219b</td> <td>Display bias value setting of input 3</td> <td>-9999 to 9998 (var : LEAD 9999 to 1)</td> </tr> <tr> <td>21AF</td> <td>Display max. value setting of input 3</td> <td>-9998 to 9999 (var : LAG 1 to 9999)</td> </tr> <tr> <td>21bP</td> <td>Display decimal point setting of input 3</td> <td>No decimal point to 3 digits decimal point</td> </tr> <tr> <td rowspan="3">21C</td> <td rowspan="3">COSφ, Hz, var display setting of input 3</td> <td>COSφ : 0.5 to 1 to 0.5 , 0 to 1 to 0</td> </tr> <tr> <td>Hz : 45 to 55Hz , 55 to 65Hz , 45 to 65Hz</td> </tr> <tr> <td>Var : LEAD □ to 0 to LAG □ (Set the □ in 219b to 21bP)</td> </tr> </tbody> </table>	Setting No.	Contents of setting	Setting value possible range	211b	Display bias value setting of input 1	-9999 to 9998 (var : LEAD 9999 to 1)	212F	Display max. value setting of input 1	-9998 to 9999 (var : LAG 1 to 9999)	213P	Display decimal point setting of input 1	No decimal point to 3 digits decimal point	214	COSφ, Hz, var display setting of input 1	COSφ : 0.5 to 1 to 0.5 , 0 to 1 to 0	Hz : 45 to 55Hz , 55 to 65Hz , 45 to 65Hz	Var : LEAD □ to 0 to LAG □ (Set the □ in 211b to 213P)	215b	Display bias value setting of input 2	-9999 to 9998 (var : LEAD 9999 to 1)	216F	Display max. value setting of input 2	-9998 to 9999 (var : LAG 1 to 9999)	217P	Display decimal point setting of input 2	No decimal point to 3 digits decimal point	218	COSφ, Hz, var display setting of input 2	COSφ : 0.5 to 1 to 0.5 , 0 to 1 to 0	Hz : 45 to 55Hz , 55 to 65Hz , 45 to 65Hz	Var : LEAD □ to 0 to LAG □ (Set the □ in 215b to 217P)	219b	Display bias value setting of input 3	-9999 to 9998 (var : LEAD 9999 to 1)	21AF	Display max. value setting of input 3	-9998 to 9999 (var : LAG 1 to 9999)	21bP	Display decimal point setting of input 3	No decimal point to 3 digits decimal point	21C	COSφ, Hz, var display setting of input 3	COSφ : 0.5 to 1 to 0.5 , 0 to 1 to 0	Hz : 45 to 55Hz , 55 to 65Hz , 45 to 65Hz	Var : LEAD □ to 0 to LAG □ (Set the □ in 219b to 21bP)	
Setting No.	Contents of setting	Setting value possible range																																													
211b	Display bias value setting of input 1	-9999 to 9998 (var : LEAD 9999 to 1)																																													
212F	Display max. value setting of input 1	-9998 to 9999 (var : LAG 1 to 9999)																																													
213P	Display decimal point setting of input 1	No decimal point to 3 digits decimal point																																													
214	COSφ, Hz, var display setting of input 1	COSφ : 0.5 to 1 to 0.5 , 0 to 1 to 0																																													
		Hz : 45 to 55Hz , 55 to 65Hz , 45 to 65Hz																																													
		Var : LEAD □ to 0 to LAG □ (Set the □ in 211b to 213P)																																													
215b	Display bias value setting of input 2	-9999 to 9998 (var : LEAD 9999 to 1)																																													
216F	Display max. value setting of input 2	-9998 to 9999 (var : LAG 1 to 9999)																																													
217P	Display decimal point setting of input 2	No decimal point to 3 digits decimal point																																													
218	COSφ, Hz, var display setting of input 2	COSφ : 0.5 to 1 to 0.5 , 0 to 1 to 0																																													
		Hz : 45 to 55Hz , 55 to 65Hz , 45 to 65Hz																																													
		Var : LEAD □ to 0 to LAG □ (Set the □ in 215b to 217P)																																													
219b	Display bias value setting of input 3	-9999 to 9998 (var : LEAD 9999 to 1)																																													
21AF	Display max. value setting of input 3	-9998 to 9999 (var : LAG 1 to 9999)																																													
21bP	Display decimal point setting of input 3	No decimal point to 3 digits decimal point																																													
21C	COSφ, Hz, var display setting of input 3	COSφ : 0.5 to 1 to 0.5 , 0 to 1 to 0																																													
		Hz : 45 to 55Hz , 55 to 65Hz , 45 to 65Hz																																													
		Var : LEAD □ to 0 to LAG □ (Set the □ in 219b to 21bP)																																													
<p>Setting method</p>	<p>If [SET] switch and [DISPLAY] switch are pressed together for longer than 3 seconds, it becomes the setting mode 2 from measurement display mode.</p> <p>For shifting to the item of display scaling setting, press [+ ] and [RESET/SHIFT] or [- ] and [RESET/SHIFT] together.</p> <p>Whenever it presses [RESET/SHIFT] switch, setting item changes.</p> <p>If COSφ or Hz display setting is being done by display scaling setting, the display bias value of the input factor, the max. value, and decimal point setting are excepted.</p>																																														

Setting method	Setting value change	<p>If a <math>\boxed{+}</math> switch or <math>\boxed{-}</math> switch is pressed, the set value will change. Set value does high-speed action gradually by continuing pressing a <math>\boxed{+}</math> or <math>\boxed{-}</math> switch.</p> <p>If a 3 digits display and 4 digits display are switched at the case of Hz display setting, if <math>\boxed{+}</math> switch is pressed with a <math>\boxed{SET}</math> switch pressed, it will change.</p> <p>In a 4 digits display, it indicates it on the 4th digit of a digital display as "4".</p>	
	Update of setting value	<p>If a <math>\boxed{SET}</math> switch is pressed, the set point will update. The upper limit (lower limit) flicker value of the updated input factor, return to default setting. (Flicker ON/OFF setting has no change.)</p>	
	Return to default setting	<p>If <math>\boxed{+}</math> and <math>\boxed{-}</math> switches are pressed together for longer than 3 seconds during setting, only as for the display scaling value of an input factor, and the upper limit and the lower limit flicker value which have been set up now, both return to a default setting.</p>	
Reset method	<p>Press the <math>\boxed{DISPLAY}</math> switch or returns to a measurement display mode by no operating it for 10 minutes.</p>		
Display	<p>• Bias setting of input 1</p> 	<p>• Max. setting of input 1</p> 	
	<p>• Decimal point setting of input 1</p> 		
	<p>• COS<math>\phi</math> setting of input 1 In case of COS<math>\phi</math>: 0.5 - 1 - 0.5</p> 	<p>• Hz setting of input 1 In case of frequency 45 - 55Hz (3 digits display)</p> 	
	<p>• var setting of input 1</p> 	<p>In case of frequency 45 - 55Hz (4 digits display)</p> 	
			



(2) Input calibration setting (Setting No. 221b to 226F)

Indicated value adjustments (zero adjustment etc.) of an input factor can be performed.

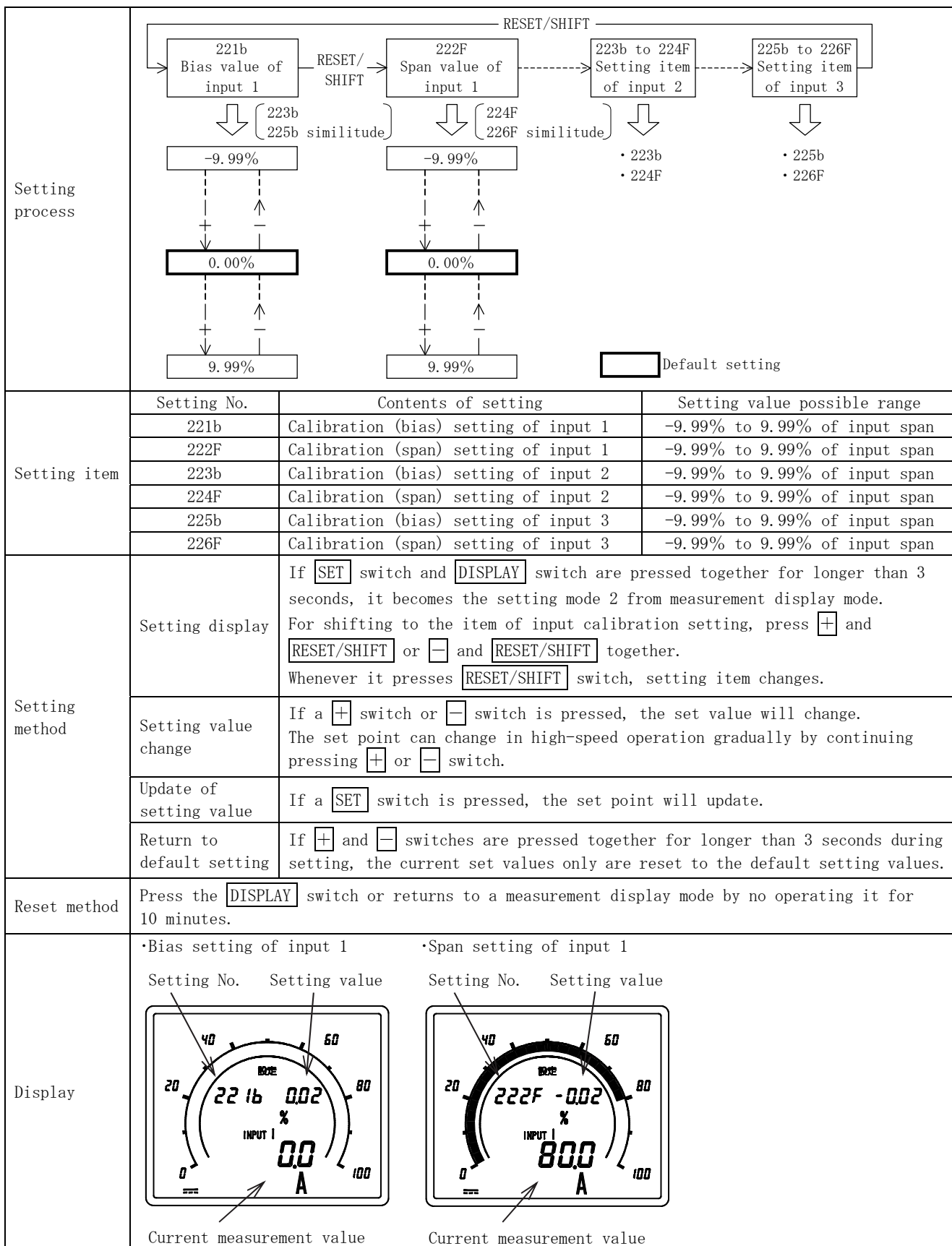

(3) Input sensitivity setting (Setting No. 231 to 233)

Sensitivity change of the bar graph display of an input factor can be performed.

<p>Setting process</p>															
<p>Setting item</p>	<table border="1"> <thead> <tr> <th>Setting No.</th> <th>Contents of setting</th> <th>Setting value possible range <sup>(12)</sup></th> </tr> </thead> <tbody> <tr> <td>231</td> <td>Input sensitivity setting of input 1</td> <td>1% to 100% of full scale</td> </tr> <tr> <td>232</td> <td>Input sensitivity setting of input 2</td> <td>1% to 100% of full scale</td> </tr> <tr> <td>233</td> <td>Input sensitivity setting of input 3</td> <td>1% to 100% of full scale</td> </tr> </tbody> </table>	Setting No.	Contents of setting	Setting value possible range <sup>(12)</sup>	231	Input sensitivity setting of input 1	1% to 100% of full scale	232	Input sensitivity setting of input 2	1% to 100% of full scale	233	Input sensitivity setting of input 3	1% to 100% of full scale		
Setting No.	Contents of setting	Setting value possible range <sup>(12)</sup>													
231	Input sensitivity setting of input 1	1% to 100% of full scale													
232	Input sensitivity setting of input 2	1% to 100% of full scale													
233	Input sensitivity setting of input 3	1% to 100% of full scale													
<p>Setting method</p>	<p>Setting display</p>	<p>If [SET] switch and [DISPLAY] switch are pressed together for longer than 3 seconds, it becomes the setting mode 2 from measurement display mode. For shifting to the item of input sensitivity setting, press [+] and [RESET/SHIFT] or [-] and [RESET/SHIFT] together. Whenever it presses [RESET/SHIFT] switch, setting item changes. If COSφ or Hz display setting is being done by display scaling setting, only the item of the input factor is excepted.</p> <p>Setting value change If a [+] switch or [-] switch is pressed, the set value will change.</p> <p>Update of setting value If a [SET] switch is pressed, the set point will update.</p> <p>Return to default setting If [+] and [-] switches are pressed together for longer than 3 seconds during setting, the current set values only are reset to the default setting values.</p>													
<p>Reset method</p>	<p>Press the [DISPLAY] switch or returns to a measurement display mode by no operating it for 10 minutes.</p>														
<p>Display</p>	<p>•Input sensitivity setting of input 1</p>														

Note<sup>(12)</sup> As for less than 39% of input sensitivity setting, the accuracy of a bar graph display differs.

(4) Communication output setting (Setting No. 241 to 246)

Setting of a communication output can be performed.

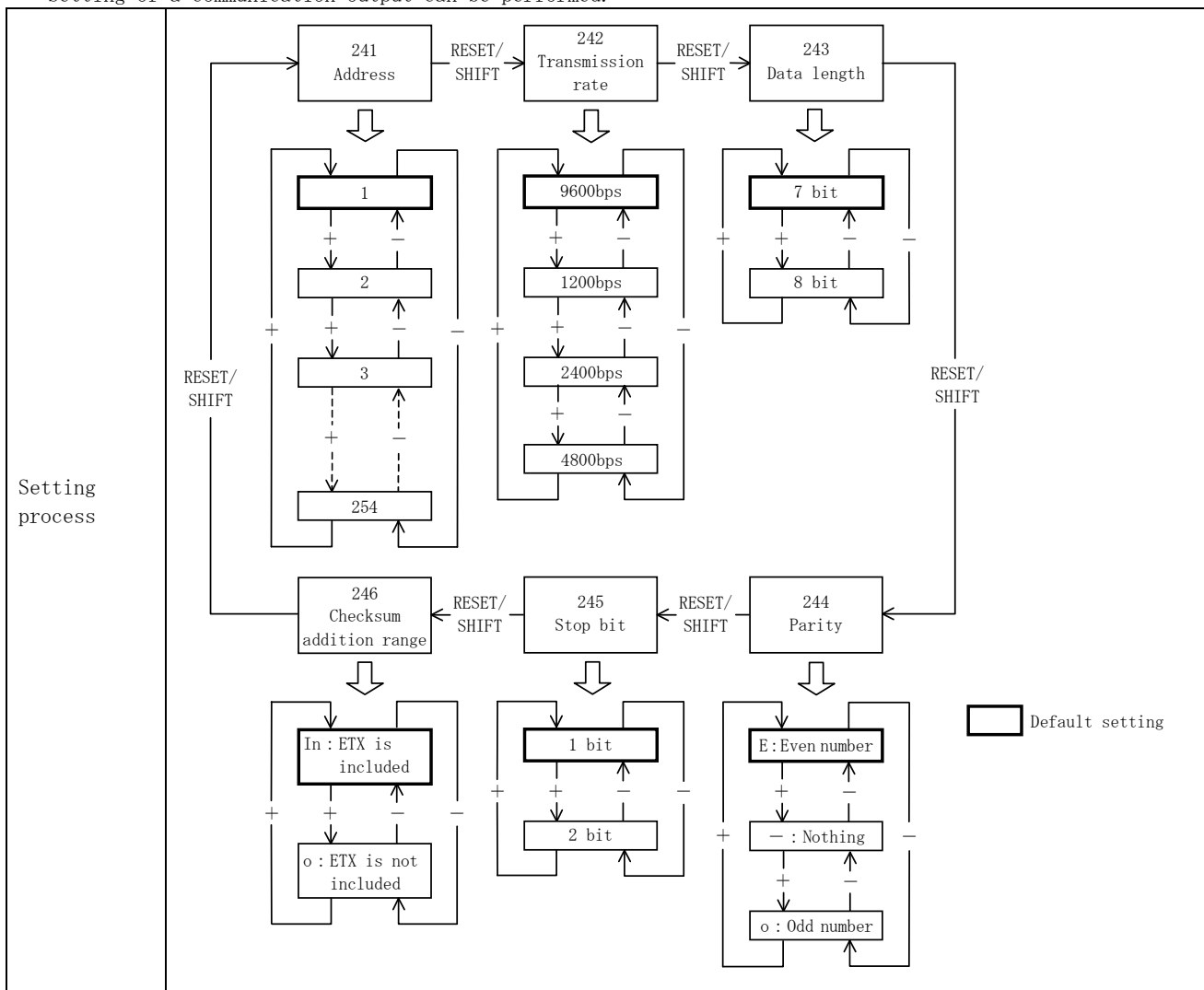

Setting item	Setting No.	Contents of setting	Setting value possible range
	241	Address	1 to 254
	242	Transmission rate	1200bps, 2400bps, 4800bps, 9600bps
	243	Data length	7 bit, 8 bit
	244	Parity	Even number (E), Odd number (o), Nothing (-)
	245	Stop bit	1 bit, 2 bit
	246	Checksum addition range	ETX is included (In), ETX is not included (o)
Setting method	Setting display	If <input type="checkbox"/> SET switch and <input type="checkbox"/> DISPLAY switch are pressed together for longer than 3 seconds, it becomes the setting mode 2 from measurement display mode. For shifting to the item of communication output setting, press <input type="checkbox"/> + and <input type="checkbox"/> RESET/SHIFT or <input type="checkbox"/> - and <input type="checkbox"/> RESET/SHIFT together. Whenever it presses <input type="checkbox"/> RESET/SHIFT switch, setting item changes.	
	Setting value change	If a <input type="checkbox"/> + switch or <input type="checkbox"/> - switch is pressed, the set value will change.	
	Update of setting value	If a <input type="checkbox"/> SET switch is pressed, the set point will update.	
	Return to default setting	If <input type="checkbox"/> + and <input type="checkbox"/> - switches are pressed together for longer than 3 seconds during setting, the current set values only are reset to the default setting values.	
Reset method	Press the <input type="checkbox"/> DISPLAY switch or returns to a measurement display mode by no operating it for 10 minutes.		

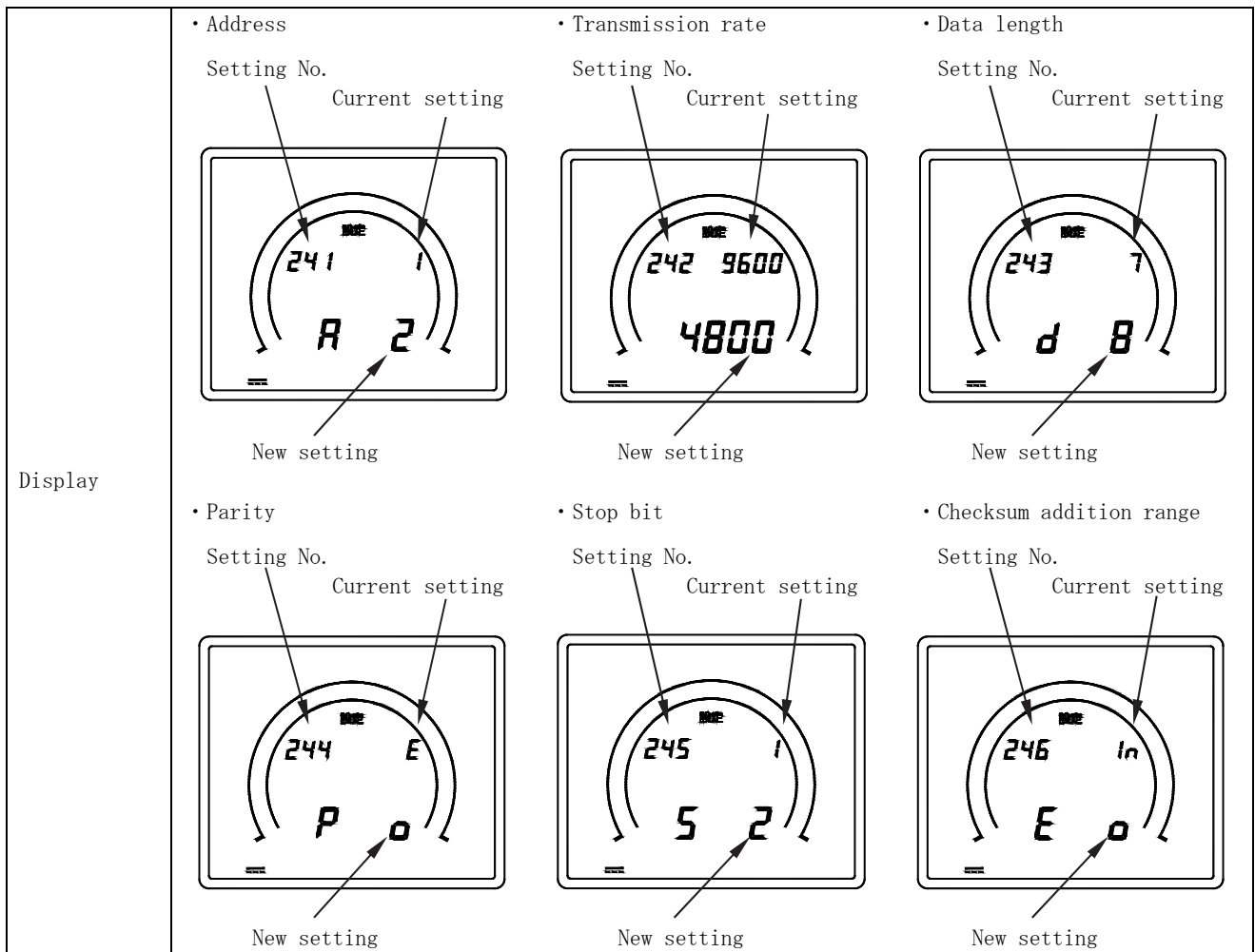

(5) Low input cut setting (Setting No. 261 to 263)

Indicated value is fixed to 0 at the case of the minute input equivalent to less than 0.5% of an input span. However, effective only at the case of display scaling 0 to N, and -N to 0 to N (example : -100 to 0 to 100). Don't function at the case of -N' to 0 to N (example : -10 to 0 to 100) and -N to 0.

<p>Setting process</p>			
<p>Setting item</p>	<p>Setting No.</p>	<p>Contents of setting</p>	<p>Setting value possible range</p>
	<p>261</p>	<p>Low input cut setting of input 1</p>	<p>ON/OFF</p>
	<p>262</p>	<p>Low input cut setting of input 2</p>	<p>ON/OFF</p>
	<p>263</p>	<p>Low input cut setting of input 3</p>	<p>ON/OFF</p>
<p>Setting method</p>	<p>Setting display</p>	<p>If <b>SET</b> switch and <b>DISPLAY</b> switch are pressed together for longer than 3 seconds, it becomes the setting mode 2 from measurement display mode. For shifting to the item of low input cut setting, press <b>+</b> and <b>RESET/SHIFT</b> or <b>-</b> and <b>RESET/SHIFT</b> together. Whenever it presses <b>RESET/SHIFT</b> switch, setting item changes.</p>	
	<p>Setting value change</p>	<p>If a <b>+</b> switch or <b>-</b> switch is pressed, the set value will change.</p>	
	<p>Update of setting value</p>	<p>If a <b>SET</b> switch is pressed, the set point will update.</p>	
	<p>Return to default setting</p>	<p>If <b>+</b> and <b>-</b> switches are pressed together for longer than 3 seconds during setting, the current set values only are reset to the default setting values.</p>	
<p>Reset method</p>	<p>Press the <b>DISPLAY</b> switch or returns to a measurement display mode by no operating it for 10 minutes.</p>		
<p>Display</p>	<p>• Low input cut setting of input 1</p>		

(6) Display dead band setting (Setting No. 271 to 273)

Set to suppress the variation in the indicated value by input variation.

<p>Setting process</p>															
<p>Setting item</p>	<table border="1"> <thead> <tr> <th>Setting No.</th> <th>Contents of setting</th> <th>Setting value possible range</th> </tr> </thead> <tbody> <tr> <td>271</td> <td>Display dead band setting of input 1</td> <td>0.0% to 2.0%</td> </tr> <tr> <td>272</td> <td>Display dead band setting of input 2</td> <td>0.0% to 2.0%</td> </tr> <tr> <td>273</td> <td>Display dead band setting of input 3</td> <td>0.0% to 2.0%</td> </tr> </tbody> </table>	Setting No.	Contents of setting	Setting value possible range	271	Display dead band setting of input 1	0.0% to 2.0%	272	Display dead band setting of input 2	0.0% to 2.0%	273	Display dead band setting of input 3	0.0% to 2.0%		
Setting No.	Contents of setting	Setting value possible range													
271	Display dead band setting of input 1	0.0% to 2.0%													
272	Display dead band setting of input 2	0.0% to 2.0%													
273	Display dead band setting of input 3	0.0% to 2.0%													
<p>Setting method</p>	<p>Setting display</p>	<p>If <b>[SET]</b> switch and <b>[DISPLAY]</b> switch are pressed together for longer than 3 seconds, it becomes the setting mode 2 from measurement display mode. For shifting to the item of display dead band setting, press <b>[+]</b> and <b>[RESET/SHIFT]</b> or <b>[-]</b> and <b>[RESET/SHIFT]</b> together. Whenever it presses <b>[RESET/SHIFT]</b> switch, setting item changes.</p> <p>Setting value change</p> <p>If a <b>[+]</b> switch or <b>[-]</b> switch is pressed, the set value will change.</p> <p>Update of setting value</p> <p>If a <b>[SET]</b> switch is pressed, the set point will update.</p> <p>Return to default setting</p> <p>If <b>[+]</b> and <b>[-]</b> switches are pressed together for longer than 3 seconds during setting, the current set values only are reset to the default setting values.</p>													
<p>Reset method</p>	<p>Press the <b>[DISPLAY]</b> switch or returns to a measurement display mode by no operating it for 10 minutes.</p>														
<p>Display</p>	<p>•Display dead band setting of input 1</p>														

(7) Measurement display ON/OFF setting (Setting No. 281 to 283)

Set the measurement display ON/OFF of an input factor.

Related output elements cannot be set for input elements that are OFF by this setting.

And in case setting the input factor of OFF, the output is OFF.

If measurement display setting is ON from OFF, because an output is still OFF, please redo setting of the output factor setting.

<p>Setting process</p>															
<p>Setting item</p>	<table border="1"> <thead> <tr> <th>Setting No.</th> <th>Contents of setting</th> <th>Setting value possible range</th> </tr> </thead> <tbody> <tr> <td>281</td> <td>Measurement display ON/OFF setting of input 1</td> <td>ON/OFF</td> </tr> <tr> <td>282</td> <td>Measurement display ON/OFF setting of input 2</td> <td>ON/OFF</td> </tr> <tr> <td>283</td> <td>Measurement display ON/OFF setting of input 3</td> <td>ON/OFF</td> </tr> </tbody> </table>	Setting No.	Contents of setting	Setting value possible range	281	Measurement display ON/OFF setting of input 1	ON/OFF	282	Measurement display ON/OFF setting of input 2	ON/OFF	283	Measurement display ON/OFF setting of input 3	ON/OFF		
Setting No.	Contents of setting	Setting value possible range													
281	Measurement display ON/OFF setting of input 1	ON/OFF													
282	Measurement display ON/OFF setting of input 2	ON/OFF													
283	Measurement display ON/OFF setting of input 3	ON/OFF													
<p>Setting method</p>	<p>Setting display</p>	<p>If <b>SET</b> switch and <b>DISPLAY</b> switch are pressed together for longer than 3 seconds, it becomes the setting mode 2 from measurement display mode. For shifting to the item of measurement display ON/OFF setting, press <b>+</b> and <b>RESET/SHIFT</b> or <b>-</b> and <b>RESET/SHIFT</b> together. Whenever it presses <b>RESET/SHIFT</b> switch, setting item changes.</p> <p>Setting value change</p> <p>If a <b>+</b> switch or <b>-</b> switch is pressed, the set value will change.</p> <p>Update of setting value</p> <p>If a <b>SET</b> switch is pressed, the set point will update.</p> <p>Return to default setting</p> <p>If <b>+</b> and <b>-</b> switches are pressed together for longer than 3 seconds during setting, the current set values only are reset to the default setting values.</p>													
<p>Reset method</p>	<p>Press the <b>DISPLAY</b> switch or returns to a measurement display mode by no operating it for 10 minutes.</p>														
<p>Display</p>	<p>• Setting of measurement display ON/OFF of an input 1.</p>														

(8) Return to default setting (Setting No. 291)

Returns all settings to their default settings.

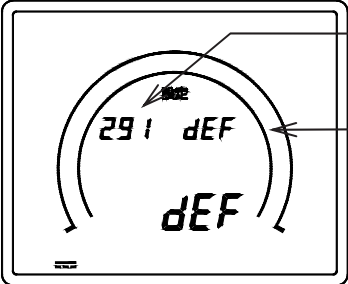
Setting process	<div style="text-align: center;"> <div style="border: 1px solid black; width: 150px; margin: 0 auto; padding: 5px;">291 Default setting</div> <p style="text-align: center;">↓ Push SET for more than 3 seconds.</p> <div style="border: 1px solid black; width: 150px; margin: 0 auto; padding: 5px;">Return to default setting</div> </div>		
Setting item	Setting No. 291	Contents of setting Return to default setting	Setting value possible range —
Setting method	Setting display	If <b>SET</b> switch and <b>DISPLAY</b> switch are pressed together for longer than 3 seconds, it becomes the setting mode 2 from measurement display mode. For shifting to the item of "return to default setting", press <b>+</b> and <b>RESET/SHIFT</b> or <b>-</b> and <b>RESET/SHIFT</b> together.	
	Return to default setting	<b>SET</b> switches are pressed for longer than 3 seconds, all the set points return to a default setting.	
Reset method	Press the <b>DISPLAY</b> switch or returns to a measurement display mode by no operating it for 10 minutes.		
Display	<ul style="list-style-type: none"> <li>• Return to default setting</li> </ul> <div style="display: flex; align-items: center;">  <div style="margin-left: 20px;"> <p>Setting No.</p> <p>Lights when initialization is execute.</p> </div> </div>		



6.6 About the scale of bar graph

- (1) A bar graph scale turns into nearest scale including the full-scale value of a display. It automatically selects from the following standard scale, and displays. And, a standard bar graph display becomes three kinds. (0 to N, -N to 0, -N to 0 to N)

Bar graph display of standard	At fragment swing	0 to N or -N to 0	-9900 ≤ N ≤ 9900
	At both swing	-N to 0 to N	

Example) Fragment swing

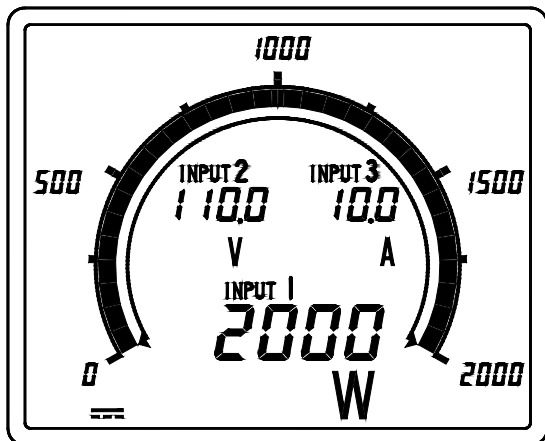

In case of display scaling setting 0 to 2000W of input 1.

Example) Both swing

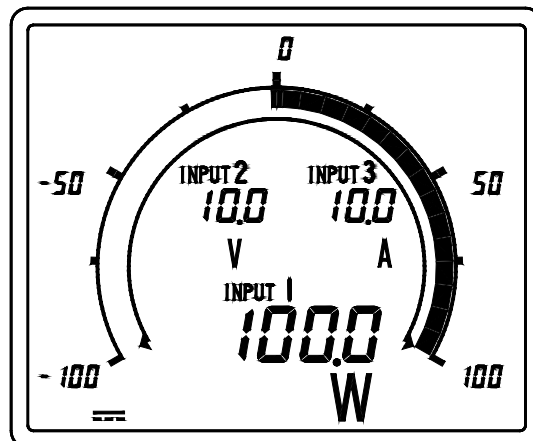

In case of display scaling setting -100.0 to 100.0W of input 1.

Standard scale	1, 1.2, 1.5, 1.6, 1.8, 2, 2.4, 2.5, 3, 3.2, 3.6, 4, 4.5, 4.8, 5, 6, 6.4, 7.2, 7.5, 8, 9, 9.6 Integral multiple of 10. (10 <sup>n</sup> )
----------------	--

- (2) In case a display full-scale value becomes between the above scale division by setting of a display scaling. The nearest bar graph scale including the value is selected.

Example) In case of display scaling setting 0 to 1900W of input 1.

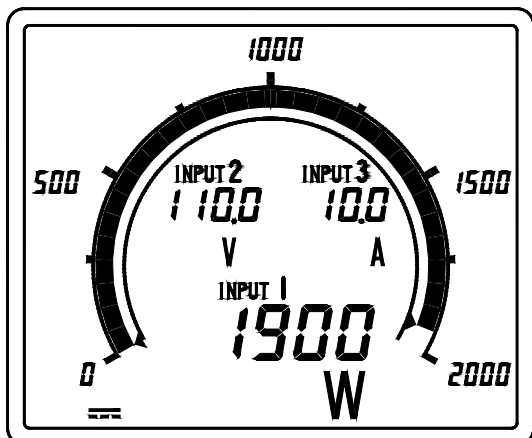

The scale of 2000 is selected because there is no scale 1900.

(The nearest bar scale including 1900 values is selected.)

Example) In case of display scaling setting -98.0 to +98.0W of input 1.

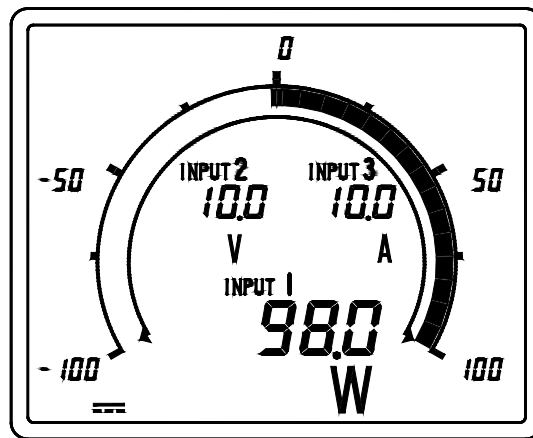

The scale of 100 is selected because there is no scale 98.

(The nearest bar scale including 98.0 values is selected.)

<Caution>

- In case of the scale which does not contain 0, such as 10 to 2000, display as the standard bar graph scale is 0 to 2000.
- In case of unbalanced scales, such as -10 to 0 to 100, display as the standard bar graph scale is -100 to 0 to 100.

- (3) Please refer to an attached chart 1 "Bar graph scale division details" about the details of each scale division.

## 7. Specification

## 7.1 Specification code, Type

① Type	② Hard model	③ Input circuit	④ Input range	⑤ Auxiliary supply	⑥ External operation input	⑦ Communication output	O	⑧ Mounting position
-----------	--------------------	-----------------------	---------------------	--------------------------	-------------------------------------	------------------------------	---	---------------------------

Product name		DC receiving meter			
①	Type (Function)	Without backlight	XLC-110		
		With backlight	XLC-110L		
		DC input × 3 circuit (MAX.)			
		Code			
②	Hard model	A	Model A , Without backlight		
		D	Model D , With backlight (White)		
③	Input circuit	6	DC input × 1 circuit		
		7	DC input × 2 circuit		
		8	DC input × 3 circuit		
④	Input range (Specification code for DC input)	1	DC1 to 5V		
		2	DC0 to 1V		
		3	DC0 to 5V		
		4	DC0 to 10V		
		5	DC4 to 20mA		
		6	DC0 to 1mA		
		7	DC0 to 5mA		
		8	DC0 to 10mA		
		9	DC0 to 16mA		
		A	DC0 to 20mA		
				Z	Other <sup>(13)</sup>
		⑤	Auxiliary supply	1	AC85 to 253V DC80 to 143V for both AC and DC uses
2	DC20 to 56V				
Z	Other				
⑥	External operation input	0	Nothing		
		2	External reset		
		Z	Other		
⑦	Communication output	A	Protocol A (RS-485 communication output)		
⑧	Mounting position (LCD view angle)	0	For upper installation (For lower view)		
		F	Wide viewing angle (Hard model D only)		

Note<sup>(13)</sup> 1) Input range standard range ..... Voltage input :  $\pm 50\text{mV}$  to  $\pm 300\text{V}$

Current input :  $\pm 500\ \mu\text{A}$  to  $\pm 50\text{mA}$

2) Input range special range ..... 1. In case all rating is not uniformity.

2. Current input :  $\pm 100\ \mu\text{A}$  to  $\pm 499\ \mu\text{A}$

(The digital display accuracy changes to  $\pm 1.0\%$  →  $\pm 1.5\%$ )

## 7.2 Specification

Item	Specification			
Number of input circuits	Maximum of 3 circuits (Mutual insulates by AC2000V.)			
Input range	Code	Input	Input resistance	Remarks
	1	DC1 to 5V	About 1M $\Omega$	Standard input range. Voltage input $\pm 50\text{mV}$ to $\pm 300\text{V}$ Current input $\pm 500\mu\text{A}$ to $\pm 50\text{mA}$
	2	DC0 to 1V	About 1M $\Omega$	
	3	DC0 to 5V	About 1M $\Omega$	Special input range. 1. In case rating is not the same. 2. Current input $\pm 100\mu\text{A}$ to $\pm 499\mu\text{A}$ (The digital display accuracy changes to $\pm 1.0\%$ $\rightarrow$ $\pm 1.5\%$ )
	4	DC0 to 10V	About 1M $\Omega$	
	5	DC4 to 20mA	About 50 $\Omega$	Input serves as 3 circuit (maximum) same rating. (Standard) Example) Input 1:4 to 20mA, Input 2:4 to 20mA, Input 3:4 to 20mA
	6	DC0 to 1mA	About 1k $\Omega$	
	7	DC0 to 5mA	About 200 $\Omega$	If the inputs are not the same, it will be "Z". (Special) Example) Input 1:4 to 20mA, Input 2:0 to 1mA, Input 3:1 to 5V
	8	DC0 to 10mA	About 100 $\Omega$	
	9	DC0 to 16mA	About 50 $\Omega$	
	A	DC0 to 20mA	About 50 $\Omega$	
Z	Other	—		
Digital display range	Digital display		-9999 to 9999	Arbitrarily setting of the position of the number of digits and decimal point.
	Power factor (COS $\phi$ ) display		(1) LEAD 0.500 to 1.000 to LAG 0.500 (2) LEAD 0.000 to 1.000 to LAG 0.000	4 digits fixation. The position of decimal point is fixed.
	Frequency display		(1) 45.0 to 55.0Hz or 45.00 to 55.00Hz (2) 55.0 to 65.0Hz or 55.00 to 65.00Hz (3) 45.0 to 65.0Hz or 45.00 to 65.00Hz	3 digits or 4 digits fixation. The position of decimal point is fixed.
	Reactive power display (LEAD, LAG)		LEAD 9999 to 0 to LAG 9999	Arbitrarily setting of the position of the number of digits and decimal point.
Bar graph display range	Maximum scale value		1, 1.2, 1.5, 1.6, 1.8, 2, 2.4, 2.5, 3, 3.2, 3.6, 4, 4.5, 4.8, 5, 6, 6.4, 7.2, 7.5, 8, 9, 9.6 Integral number times of 10. (10 <sup>n</sup> )	However range of $-9900 \leq N \leq 9900$
	Power factor (COS $\phi$ ) display		(1) LEAD 0.5 to 1 to LAG 0.5 (2) LEAD 0 to 1 to LAG 0	A scale value is fixed. Only at the case of power factor display selection, LEAD and LAG displays.
	Frequency display		(1) 45 to 55Hz (2) 55 to 65Hz (3) 45 to 65Hz	A scale value is fixed.
	Reactive power display (LEAD, LAG)		LEAD□ to 0 to LAG□ □ is the same numerical value as the above maximum scale.	However, the range of LEAD 9900 to 0 to LAG 9900. Only at the case of reactive power display selection, LEAD and LAG indicates.

Item	Specification									
	LCD (18 types) <sup>(14)</sup>		Unit lettering display (55 type) <sup>(16)</sup>							
Standard unit	(1)	A	(1)	APm	(19)	L/h	(37)	Nm <sup>3</sup> /min	(55)	度
	(2)	kA	(2)	bar	(20)	L/min	(38)	N/m <sup>2</sup>		
	(3)	kV	(3)	cm	(21)	mA	(39)	N/mm <sup>2</sup>		
	(4)	kW <sup>(15)</sup>	(4)	COS $\phi$	(22)	mg/L	(40)	OPm		
	(5)	m	(5)	ELm	(23)	min <sup>-1</sup>	(41)	Pa		
	(6)	m/h <sup>(15)</sup>	(6)	Hz	(24)	mL/min	(42)	pH		
	(7)	m/min <sup>(15)</sup>	(7)	J	(25)	mm	(43)	ppm		
	(8)	min	(8)	K	(26)	m/h <sup>(17)</sup>	(44)	R		
	(9)	m <sup>3</sup>	(9)	kg	(27)	m/min <sup>(17)</sup>	(45)	rad		
	(10)	m <sup>3</sup> /h	(10)	kg/h	(28)	m/s	(46)	rpm		
	(11)	m <sup>3</sup> /min	(11)	kg/m <sup>2</sup>	(29)	MV	(47)	SPm		
	(12)	MW <sup>(15)</sup>	(12)	kg/m <sup>3</sup>	(30)	m <sup>3</sup> /s	(48)	t		
	(13)	r/min	(13)	kL	(31)	Mpa	(49)	t/h		
	(14)	V	(14)	kN	(32)	Mvar	(50)	TPm		
	(15)	W <sup>(15)</sup>	(15)	kPa	(33)	MW <sup>(17)</sup>	(51)	W <sup>(17)</sup>		
	(16)	%	(16)	kvar	(34)	N	(52)	YPm		
	(17)	°C	(17)	KW <sup>(17)</sup>	(35)	N•m	(53)	μm		
	(18)	No unit	(18)	L	(36)	Nm <sup>3</sup> /h	(54)	μS/cm		

Note<sup>(14)</sup> LCD, Main monitor : 18 types. Sub-monitor : 13 types.

Note<sup>(15)</sup> LCD display is possible only for the main monitor. Sub-monitor cannot display of LCD.

Note<sup>(16)</sup> Lettering display. Main monitor : 50 types, Sub-monitor : 55 types.

Lettering character height. Main monitor : 8.5mm, Sub-monitor : 5mm.

The character color of lettering, Gray (DIC, The 13th edition, 541)

Note<sup>(17)</sup> A lettering display is possible only for a sub-monitor. The main monitor serves as a liquid crystal display.

## 7.3 Performance

Item		Specification		
Accuracy of digital display		$\pm 1.0\%$		
Accuracy of bar graph		$\pm 5.0\%$ (% for span)		
Influence of temperature		$23 \pm 10^\circ\text{C}$ in accuracy		
Conformity technical standard		JIS C 1102-1 : 1997 ... Direct acting indicating analogue electrical measuring instruments and their accessories. Part 1 : Definitions and general requirements common to all parts.		
		JIS C 1102-2 : 1997 ... Direct acting indicating analogue electrical measuring instruments and their accessories. Part 2 : Special requirements for ammeters and voltmeters.		
		JIS C 1102-7 : 1997 ... Direct acting indicating analogue electrical measuring instruments and their accessories. Part 7 : Special requirements for multi-function instruments.		
		JIS C 1102-9 : 1997 ... Direct acting indicating analogue electrical measuring instruments and their accessories. Part 9 : Recommended test methods.		
		JIS C 1111 : 1989 ..... Electrical measuring transducers for converting a.c. electrical quantities into d.c. electrical quantities.		
		JIS C 1010-1 : 1998 ... Safety requirements for electrical equipment for measurement, control, and laboratory use. Part 1 : General requirements.		
Display updating time		About 1 second (Bar graph of about 0.25 second)		
Display device, Display composition		Main monitor	Character height 10mm, 4 digits	
		Sub-monitor (Left), (Right)	Character height 6mm, 4 digits	
		Bar graph	30 dots	
Auxiliary supply	XLC-110 (Without back light)	(1) AC85 to 253V 50/60Hz 10VA (Rated voltage AC100/110V, 200/220V) DC80 to 143V 5W (Rated voltage DC100/110V) for both AC and DC uses	(1) or (2). Designate	
		(2) DC20 to 56V 6W (Rated voltage DC24/48V)		
	XLC-110L (With back light)	(1) AC85 to 253V 50/60Hz 12VA (Rated voltage AC100/110V, 200/220V) DC80 to 143V 6W (Rated voltage DC100/110V) for both AC and DC uses		
		(2) DC20 to 56V 7W (Rated voltage DC24/48V)		
	Rush current (Time constant)	Rated voltage AC110V Less than 5.2A (About 1.7ms)		
		Rated voltage AC220V Less than 10.4A (About 1.7ms)		
Rated voltage DC110V Less than 3.7A (About 1.7ms)				
Rated voltage DC24V Less than 5.5A (About 3.6ms)				
Rated voltage DC48V Less than 10.9A (About 3.6ms)				
Overload capacity		Voltage circuit	2 times 10 seconds, 1.2 times continuation of rated voltage	
		Current circuit	10 times 5 seconds, 1.2 times continuation of rated current	
		Auxiliary supply	1.5 times 10 seconds, 1.2 times continuation of rated voltage. In case of DC110V, 1.5 times 10 seconds, 1.3 times continuation of rated voltage.	
Insulation resistance		Between electric circuit and a case (ground).	Above $50\text{M}\Omega$ at DC500V megger.	
		Between input, output, auxiliary supply.		
		Between inputs.		
Withstand voltage		Between electric circuit and a case (ground).	AC2000V (50/60Hz) 1 minute	
		Between input, output, auxiliary supply.		
		Between inputs.		
Impulse withstand voltage		Between electric circuit and a case (ground).	5kV $1.2/50\mu\text{s}$ Positive and negative polarity for each 3 times	

Item	Specification
Noise-capacity	<p>(1) Oscillatory surge voltage If a vibration damping waveform (1 to 1.5MHz, peak voltage : 2.5 to 3kV) is repeated and added, error is less than <math>\pm 10\%</math>. Voltage circuit, current circuit (Common) Auxiliary supply circuit (Normal / Common)</p> <p>(2) Square wave impulse noise If a noise (<math>1\mu\text{s}</math>, 100ns width) is repeated and it adds for 5 minutes, error is less than <math>\pm 10\%</math>. Voltage, current circuit (Common) Over 1.5kV Auxiliary supply circuit (Normal / Common) Over 1.5kV External operation input (Common) Over 1.0kV Communication output (Induction) Over 1.0kV</p> <p>(3) Wave noise If the intermittence irradiation of the wave (5W, 1m) of 150MHz, 400MHz band is done, and if the intermittence irradiation of the wave (1m) of a cellular phone is done, error is less than <math>\pm 10\%</math>.</p> <p>(4) Electrostatic noise At the 8kV at power distribution, error is less than <math>\pm 10\%</math>. There needs to be no 10kV damage at the case of the non-power distribution. Condenser charge form.</p>
Vibration, shock	Vibration : Single amplitude 0.15mm, 10 to 55Hz, Each minute octave in 5 times sweep Shock : $490\text{m/s}^2$ Each direction 3 times
Construction	Dimension : 110mm (Width) $\times$ 110mm (Height) $\times$ 104.5mm (Depth) Body diameter : 99mm $\phi$ With terminal cover
Material	Case, Cover : ABS(V-0) , Terminal block : PBT , Terminal cover : Polycarbonate
Color	Black (Munsell N1.5)
Mass	Approx. 520g
Warranty at blackout	Maximum value, Minimum value, Setting value. Nonvolatile memory in data holds.
Operation temperature and humidity range	-10 to +55°C, 30 to 85% RH Non condensing.
Storage temperature range	-25 to +70°C

## 7.4 Option specifications [Production of the following products with input and output is possible by designating.]

Item	Specification	
Communication output	Standard	EIA RS-485
	Transmission system	Half duplex two-wire system
	Synchronous method	Asynchronous communication
	Transmission rate	1200bps / 2400bps / 4800bps / 9600bps
	Line code	NRZ
	Start bit	1 bit
	Data length	7 bit / 8 bit
	Parity bit	Nothing / Odd number / Even number
	Stop bit	1 bit / 2 bit
	Cable length	1000m (Total extension)
	Address	1 to 254
	Transmission character	ASCII code
	Please read a communication specification for details.	
External operation input	Input factor	External reset ×1
	Input specification	External reset : By applying a voltage signal from the outside, the maximum value and the minimum value are reset. An input is the same rating as an auxiliary power supply. (1) AC100/110V 0.4VA, AC200/220V 1.4VA, DC100/110V 0.4W for both AC and DC uses Contact capacity : About 3mA (AC, DC100/110V), About 6mA (AC200/220V) (2) DC24V 0.3W, DC48V 1.2W Contact capacity : About 10mA (DC24V), About 20mA (DC48V)

● Caution on the use of external operation input (Option)

Power consumption of external operation input is 0.4VA at AC110V or 1.4VA at AC220V or 0.4W at DC110V.

When a relay or a switch is used for power feed, its minimum application load should be about 1mA.

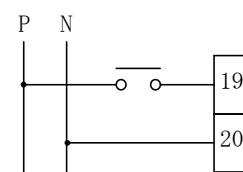

## 8. Trouble shooting

Symptoms	Possible causes	Remedial measures
Indicator does not display.	The power supply is not supplied. (Not connected. or voltage is low)	Check the auxiliary supply. Reapply of auxiliary power.
	Measurement display ON/OFF setting is set to OFF.	Please check setting
	Trouble of products.	Replace the products.
The error of measurement value is large.	Range setting is not right.	Please set again.
Communication error	Communication cable is disconnection, or connection is not right. (Polarity etc.)	Please check the communication cable.
	Setting of communication is not right. (Address, Transmission rate, Data length, Parity, Stop bit, Checksum addition range)	Please check setting.

Attached chart 1.

Bar graph scale division details.

The number in a bar graph scale is equivalent to the number of the following figure liquid crystal screen.

(A number is not displayed on actual liquid crystal.)

And, scale division changes with full-scale values.

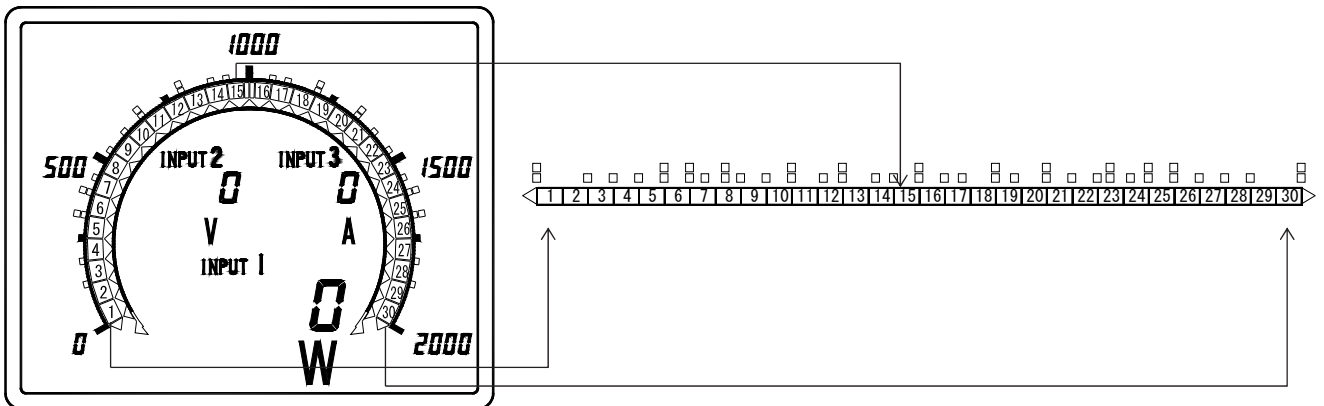

At fragment swing.

(0 to N)

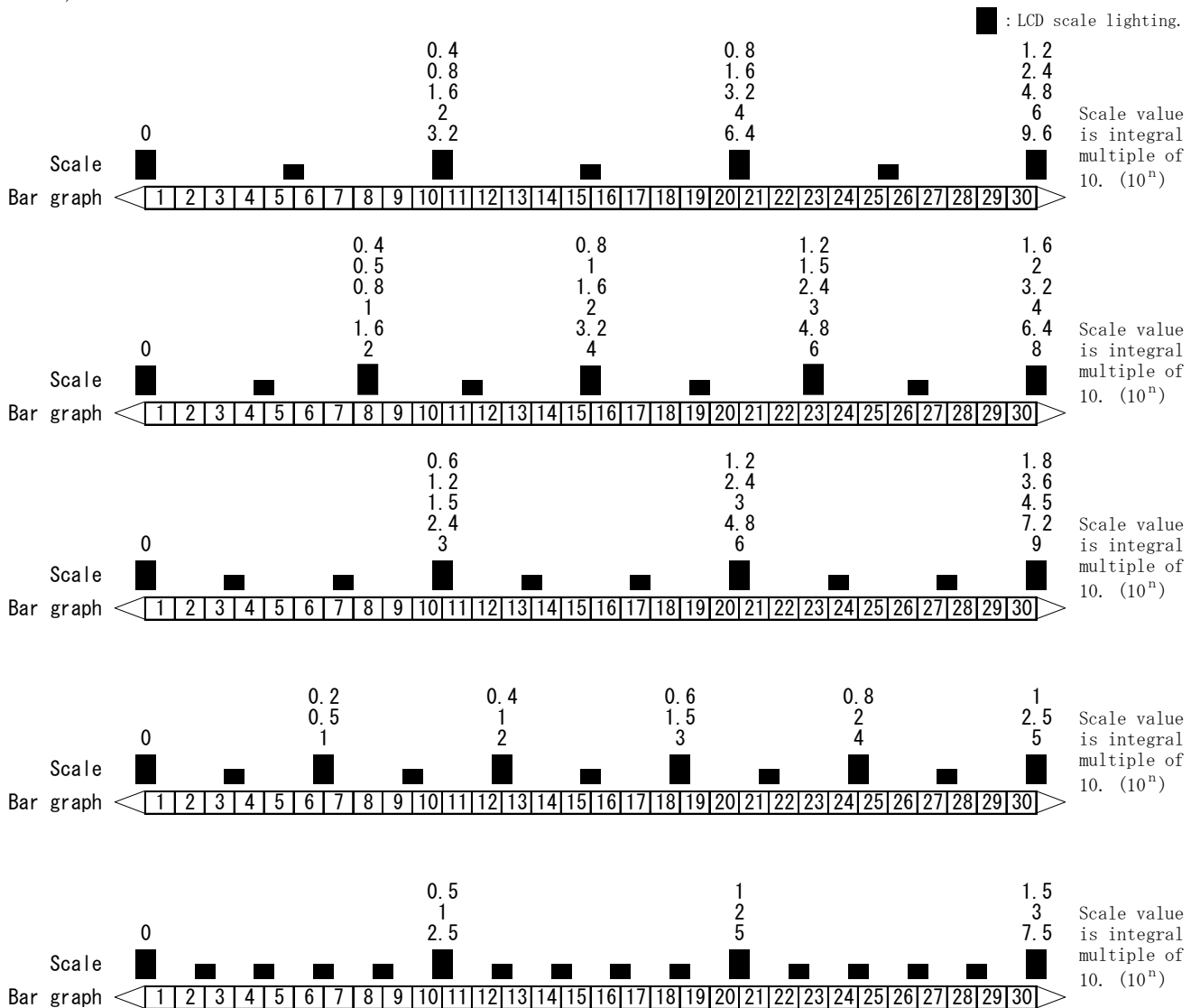



At fragment swing.  
 (-N to 0)

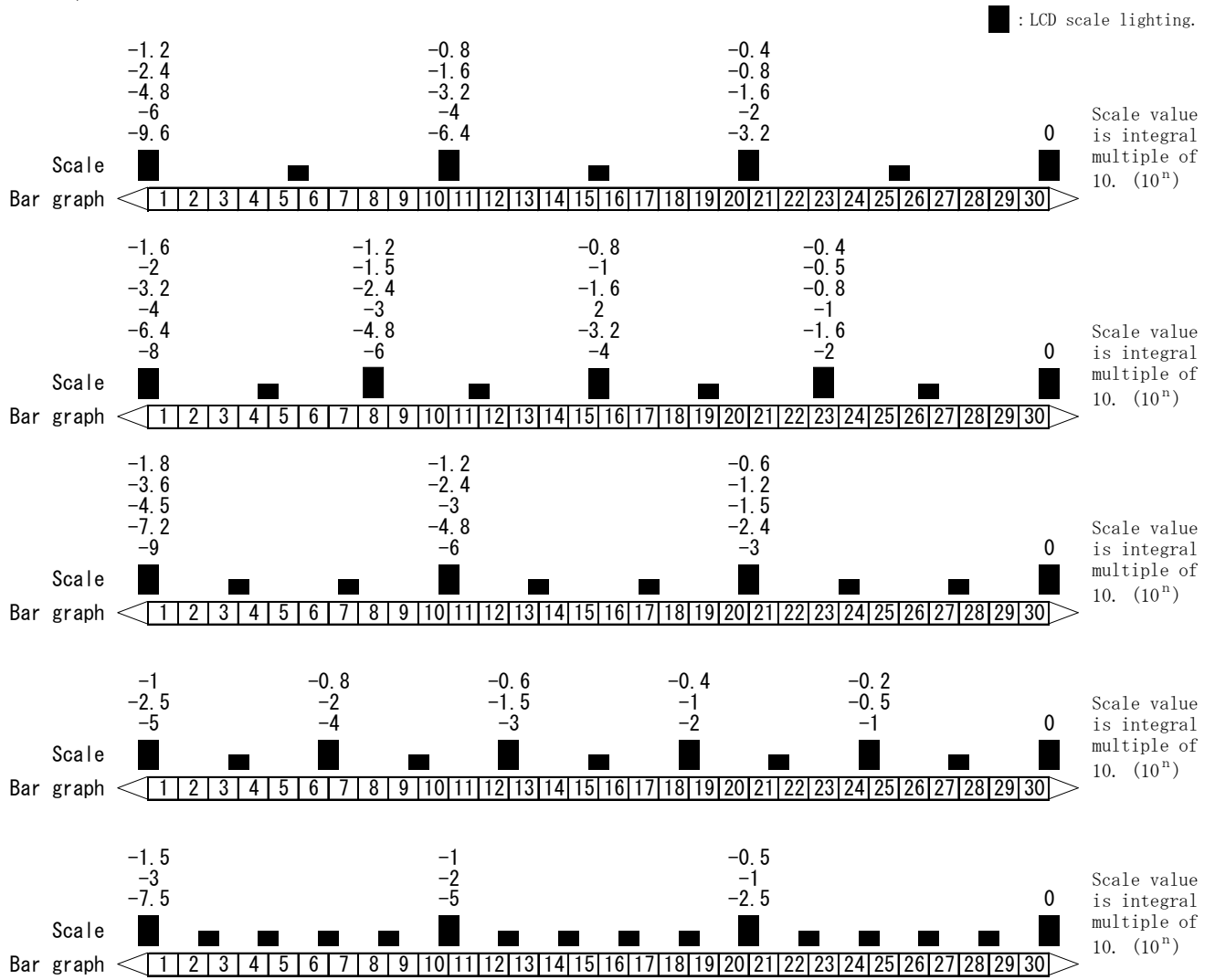

At both swing.  
(-N to 0 to N)

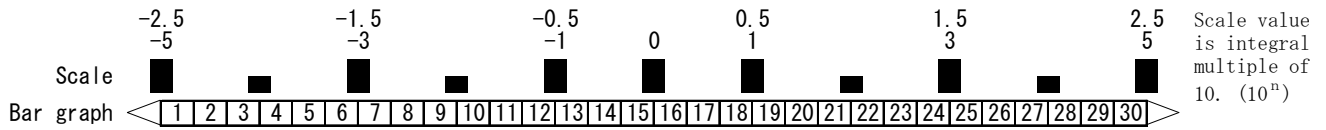
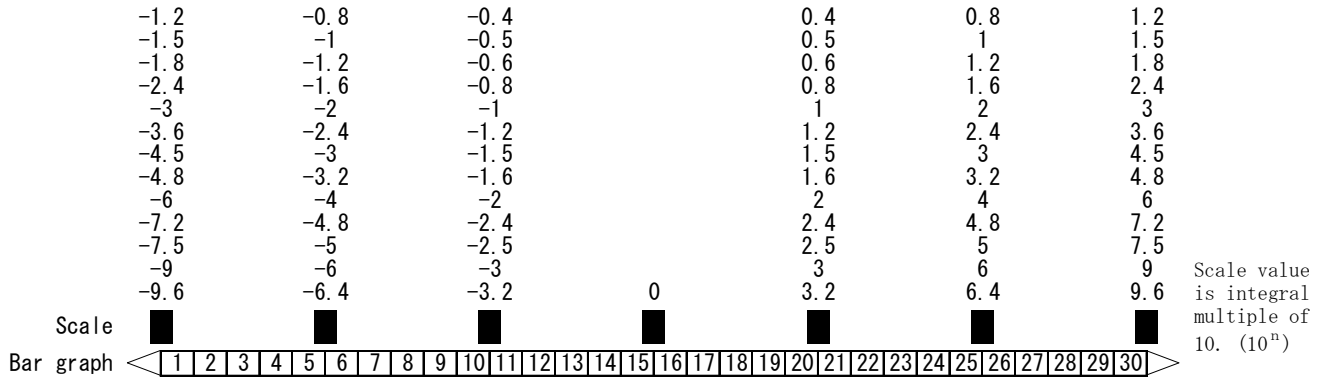
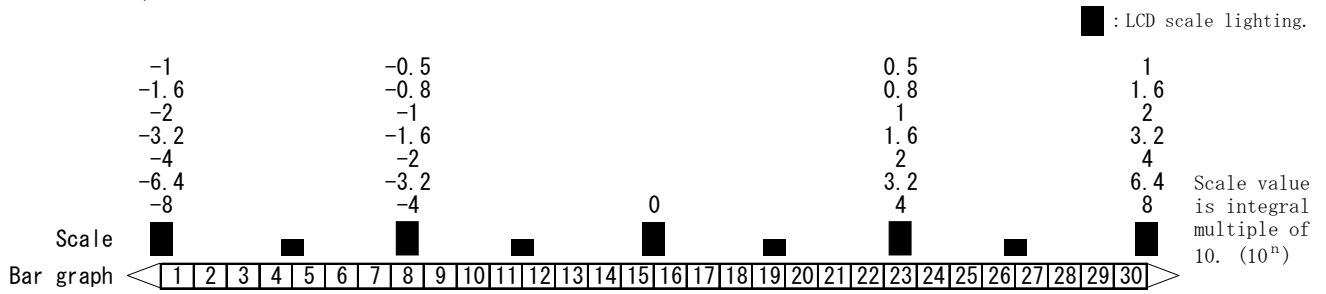

Frequency (Hz)

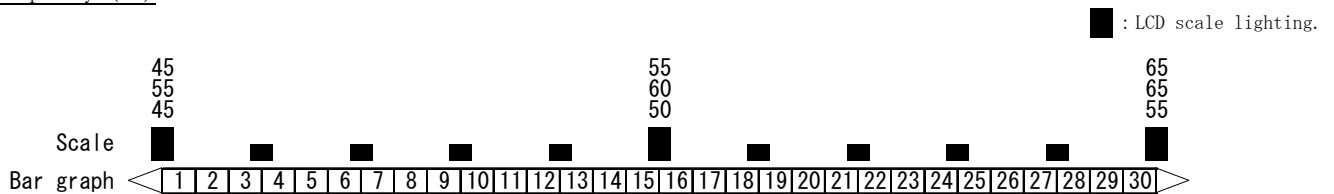

Power factor (COS  $\phi$ )

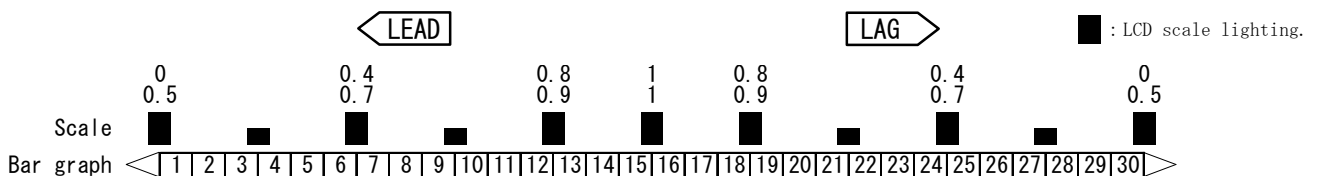

Reactive power (var)

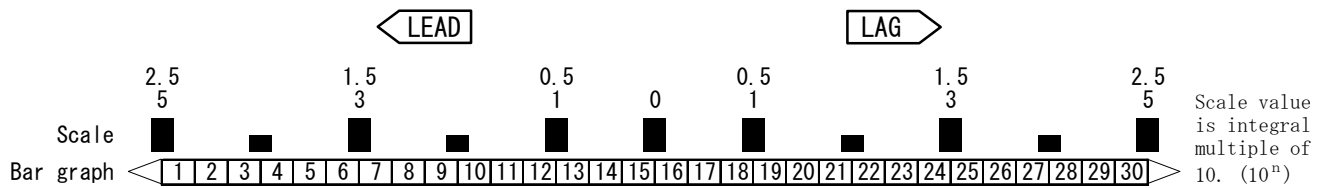
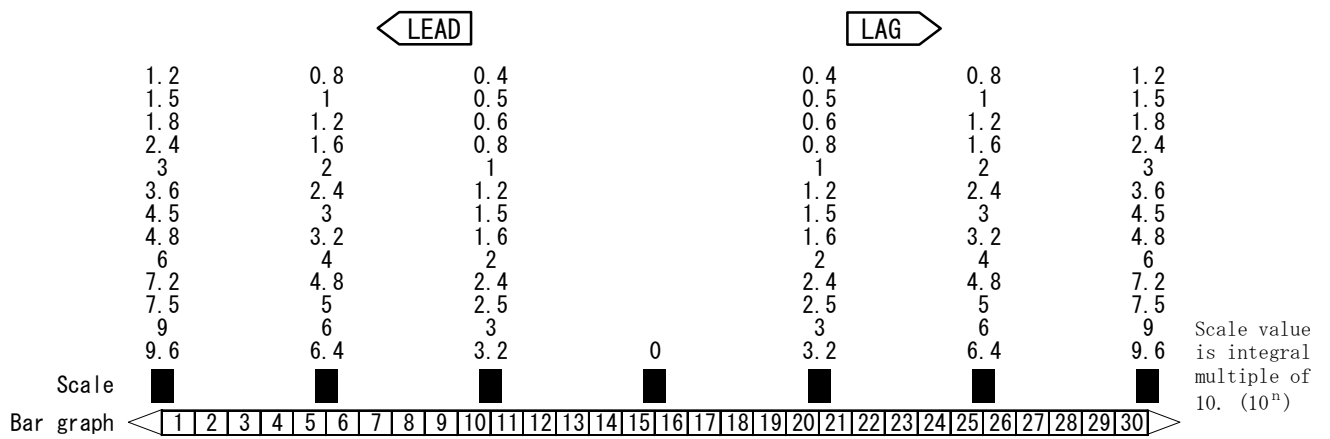
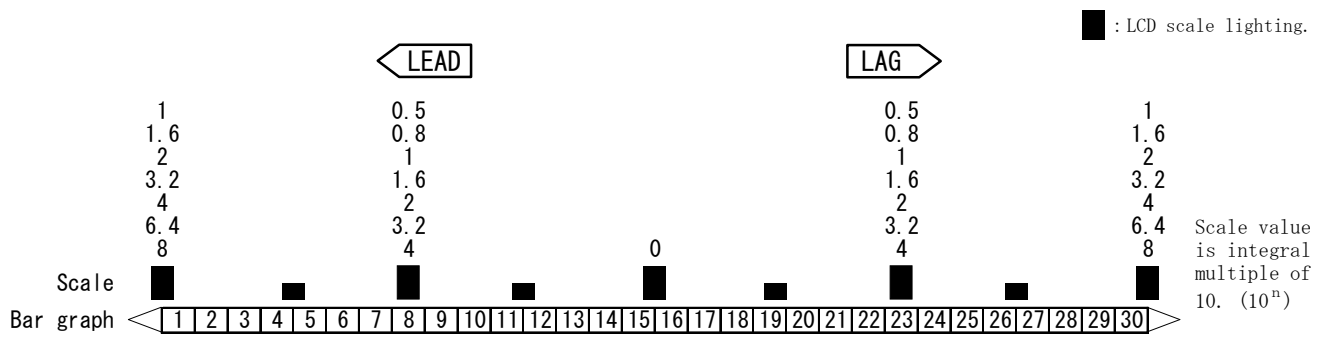

 **DAIICHI ELECTRONICS CO., LTD.**

Head Office : 11-13 Hitotsuya 1-chome, Adachi-ku, Tokyo, 121-8639 Japan.  
Phone : 03-3885-2411 , Fax : 03-3858-3966

Kyoto Office : 1-19 Ichinobe-Nishikawahara, Jyoyou-shi, Kyoto, 610-0114 Japan.  
Phone : 0774-55-1391 , Fax : 0774-54-1353

DATE : May 21, 2010