

# INSTRUCTION MANUAL

DC MULTI METER

TLC-110

HARDWARE MODEL A 【Without backlight】

TLC-110L

HARDWARE MODEL D 【White backlight】

Thank you for purchasing DAIICHI ELECTRONICS product.  
Please read this instruction manual carefully before using.

## Safety precautions

### ■ Environment conditions

Please be sure to use this product in a place that meets the following conditions.

In places that do not meet this condition, it may cause malfunction or failure and product life decline.

- Within the range of ambient temperature -10 to +55 °C, humidity exceeding 85% RH.
- Place free of dust, corrosive gas, salt and oily smoke. (Corrosive gas : SO<sub>2</sub> / H<sub>2</sub>S, etc.)
- Location that is not affected by vibration and shock.
- Location that is not affected by external noise.
- Altitude 1000m or less.

### ■ Outdoor use conditions

- These products are not a dustproof, waterproof, and splash proof construction.

Please avoid the place with much dust. Moreover, please install in the place not exposed to rain or water drop.

- Please do not install in the place where sunlight hits directly.

Discoloration and degradation of a name plate, and deformation of the case by the surface temperature rise may occur.

### ■ Mounting and wiring

Please refer to this instruction manual for mounting and the wiring.

 <b>CAUTION</b>	<ul style="list-style-type: none"> <li>● Please refer to connection diagram for the wiring.</li> <li>● Please avoid hot line work.</li> <li>● Please use an electrical wire size suitable with the rated current.</li> <li>● Please check the tightening of the screw.</li> <li>● Please attach the terminal cover after work is completed</li> </ul>
--	---

### ■ Preparation

- When connecting this product directly to the main power supply, attach an appropriate fuse to the outside.
- This product must be set before use. Please set correctly after reading this instruction manual.

### ■ About use

Be careful with the following cautions during use.

- Use the input within the rated range.
- Close the switch cover when the unit is not operated.
- This product has a function to hold the maximum and minimum values depending on the measurement element. This value is guaranteed for power failure and is not cleared by a power reset. However, if no input is applied when the power is turned on, the minimum value may be updated. To keep the past minimum value when turning on the power, apply the input within 1 second after turning on the power.

 <b>CAUTION</b>	<ul style="list-style-type: none"> <li>● Be careful not to touch any terminal when power is applied to the unit.</li> <li>● Don't disassemble or modify this unit without any previous permission of our company. Modifications may cause troubles, a fire, or other accidents. For specifications change, etc., please contact us.</li> </ul>
--	--

### ■ Setting

This product requires setting and confirmation such as unit display before use. In the case of use in the initial setting, there is no need of setting and confirmation. If the setting is wrong, the measurement and output may not work properly. Read the instruction manual before setting.

### ■ About dew condensation

If the temperature and humidity of an installation change rapidly when a product is a non-energization, the waterdrop by dew condensation may adhere to a display inner side. (The display filter and the LCD surface stick and the pattern of the shape of a circle or an ellipse occur.)

This phenomenon does not cause any trouble. Disappears when control power is applied for 2 hours.

## ■ Maintenance and inspection

- Inspection in energized state is dangerous.
- Check that the measured values, scale, units, etc. are displayed correctly.
- Check that there is no discoloration of the LCD or damage to the case. Also check that there are no loose wiring or mounting screws.
- No replacement in periodic inspection.
- Please wipe off lightly with the dry soft cloth. Please do not use the organic solvent, chemicals, cleaners, etc., such as an alcohol, for cleaning.  
The LCD screen may light up during wiping, which is caused by static electricity on the filter.  
If left for a while, it will discharge naturally and return to its original state.  
Also, when pressing the filter, the filter may come into contact with the liquid crystal display surface, causing a round or elliptical pattern. Do not press the filter strongly.

## ■ Storage

Please store in a place that meets the following conditions.

- Within the range of ambient temperature -20 to +70 °C, humidity exceeding 5 to 90% RH.
- Daily average temperature 40 °C or less.
- Location corresponding to the usage environment and use conditions.
- Aluminum electrolytic capacitors are used in products. Please energize the power supply within one year after purchase.

## ■ Countermeasures against troubles

If trouble occurs within the warranty period, DAIICHI ELECTRONICS will repairs this product.

## ■ Disposal

Please dispose this product as industrial waste (non-combustible).

Mercury parts and a nickel-cadmium battery are not used for this product.

## ■ Warranty period

The warranty period of the product is one year after the date of delivery.

## ■ Warranty scope

In the state of the normal use of product-specification within the range according to this instruction manual, the trouble within the warranty period performs exchange or repair gratuitously.

However, the shipping expenses and the packing cost in the case of shipping obtain as payment on a customer.

And, if it corresponds to the next, it does not warrant.

- If it breaks down when converted or repaired except our company.
- Failures caused by violation of various conditions concerning use, storage, etc. specified by the Company.
- If the cause of trouble is based on cause other than this product.
- Transportation, movement, damage by falling, and trouble.
- Other cases where the supplier is not responsible, such as a natural disaster or disaster.

Only a product simplex is applied with a warranty. We cannot bear the responsibility such as the damage and the loss that occurred by the use of this product and trouble or the loss of profits.

And, a warranty is effective only in Japan.

## ■ Changes to the contents of the instruction manual

Please note that the contents of this instruction manual are subject to change without notice due to product improvements.

## Content

1. Instructions on the product	
1.1 Application	4
1.2 Features	4
2. Names and functions of component parts	5
3. Preparation	
3.1 Mounting	6
3.2 Connections	7
3.2.1 Connection diagram	7
3.2.2 Cautions on connections	8
4. Operation	8
5. Display	9
6. Setting	
6.1 Function table and default setting	13
6.2 Example of setting function	16
6.3 Setting table	19
6.4 Measurement display-mode in detail explanation	22
6.5 Setting detail explanatory	26
6.5.1 Setting mode 1	26
6.5.2 Setting mode 2	35
6.6 Integrated value (Wh) reset	46
6.7 About the scale of bar graph	47
7. Specification	
7.1 Specification code, Type	48
7.2 Specification	49
7.3 Performance	51
7.4 Option specifications	54
8. Trouble shooting	55

Attached chart 1. Bar graph scale division details.

Appendix table 1. Power measurement scaling list.

## 1. Instructions on the product

### 1.1 Application

This product can measure the voltage (or current) of a DC circuit to 3 circuits.

The intensive monitor combined with the system by adding analog output to this product is possible.

### 1.2 Features

- 3 measurement can display simultaneously.
- This product has a scaling function that can set the full scale to any measurement value.
- From the measurement value of a DC current and DC voltage, it calculates a DC power (W) and the DC electric energy (Wh), and can perform a display and an output.
- The withstand voltage between inputs and between inputs and outputs is 2000V.
- Bar graph display (1 measurement) can be checked like meter.
- The maximum and the minimum value of a measurement display can be held.
- Upper limit and lower limit flicker setting is possible (with setting index).  
This index can also be used as a control index when the flickering function is turned off.
- Three analog output circuits or two analog circuits and pulse output can be taken out. (option)
- An external operation input (reset of the maximum value and the minimum value) is possible. (option)
- Power supply is AC85 to 253V or DC80 to 143V (for both AC and DC uses). DC20 to 56V can also make.
- The mounting method of this unit is compatible with the mounting method of conventional 110 square mechanical meter. This unit is mounted at 2 diagonal points.
- With backlight function (TLC-110L)  
Always-on, Auto off (after 5 minutes without operating), Always-off and brightness setting is possible.  
LED: White

2. Names and functions of component parts

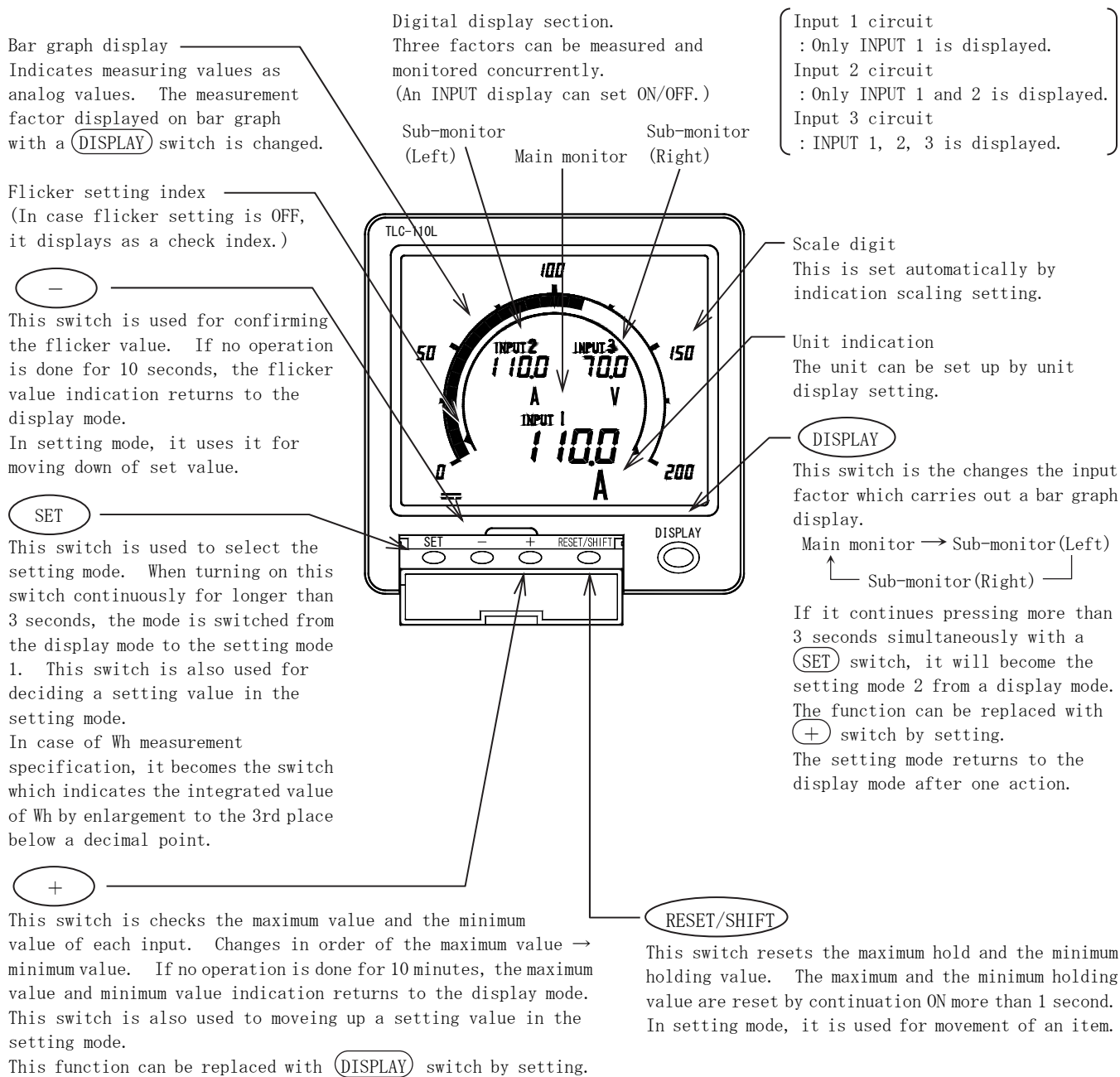

### 3. Preparation

#### 3.1 Mounting

Refer to the external dimensions and panel cut, and mount in the panel (with a thickness of 10 mm or less) with the M5 nut provided.

● Dimensions diagram

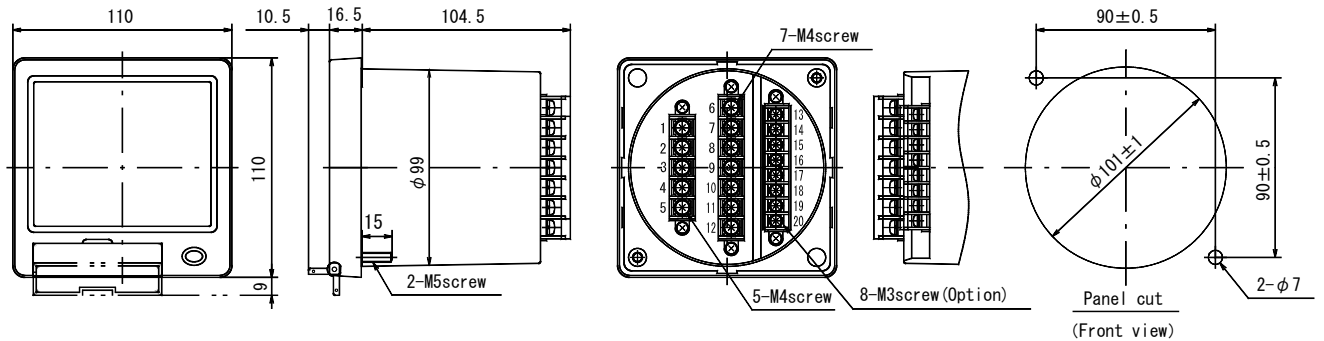

● LCD viewing angle

Mounting: Since the contrast of the LCD changes depending on the viewing angle, mount it at the optimal angle.

(1) Wide viewing angle model

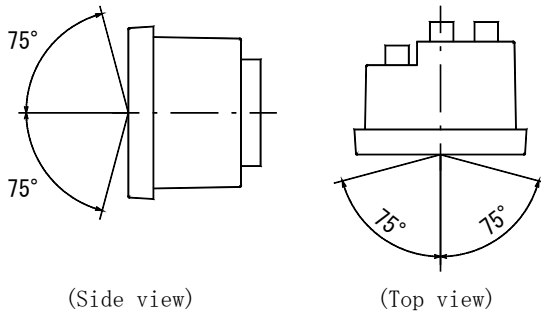

(2) For upper case installation

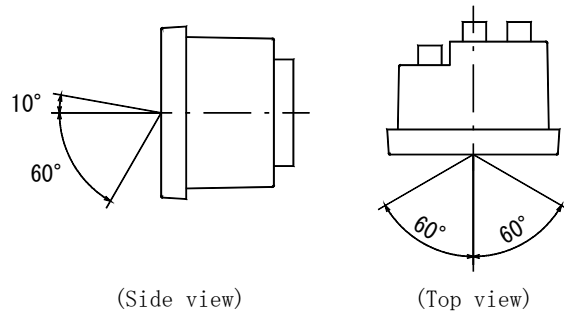

● Mounting

- (1) Insert the product into the cut hole of the panel from the front.
- (2) Secure the product with the mounting M5 flange nut (accessory).  
The tightening torque of the flange nut should be 2.0 to 2.5 N·m.

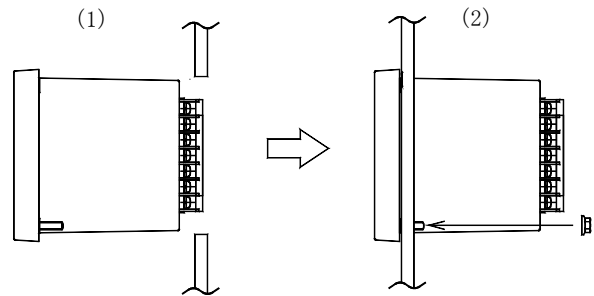

● Series-resistance DM-1 (accessories) dimension diagram

(If a voltage input is above 301V, it uses series-resistance DM-1.)

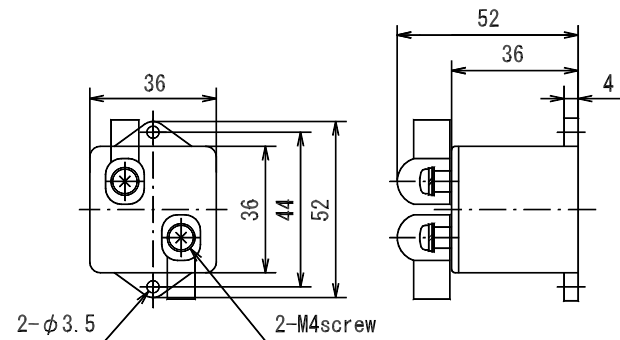

### 3.2 Connections

#### 3.2.1 Connection diagram

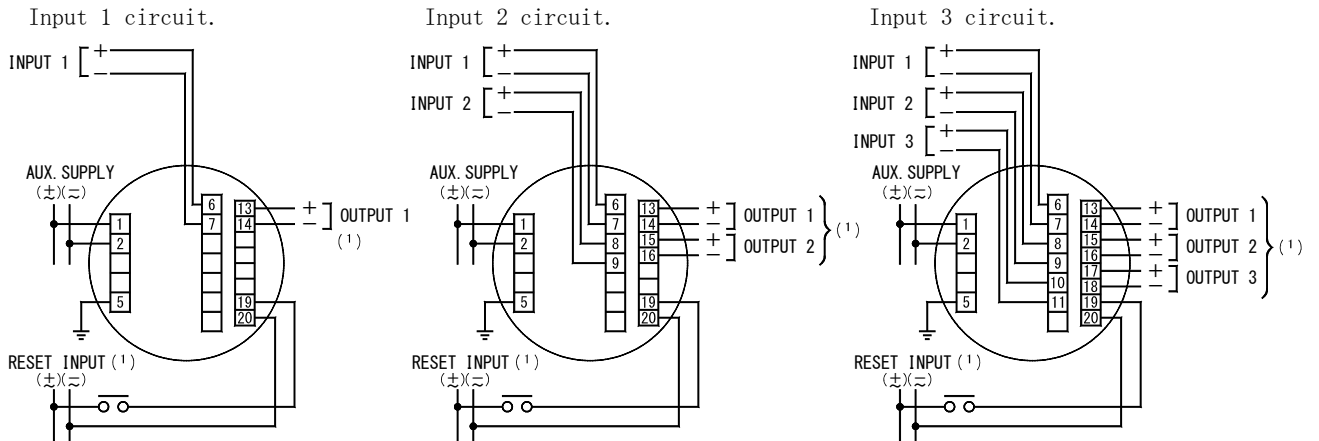

The example of connection in series-resistance.  
 If a voltage input is above 301V, it combines 1mA meter and series-resistance (DM-1, accessories).

Connection of DC power (W) measurement and DC electric energy (Wh) measurement.

A shunt is an option. If a voltage input is above 301V, it uses it combining a series-resistance (DM-1, accessories).

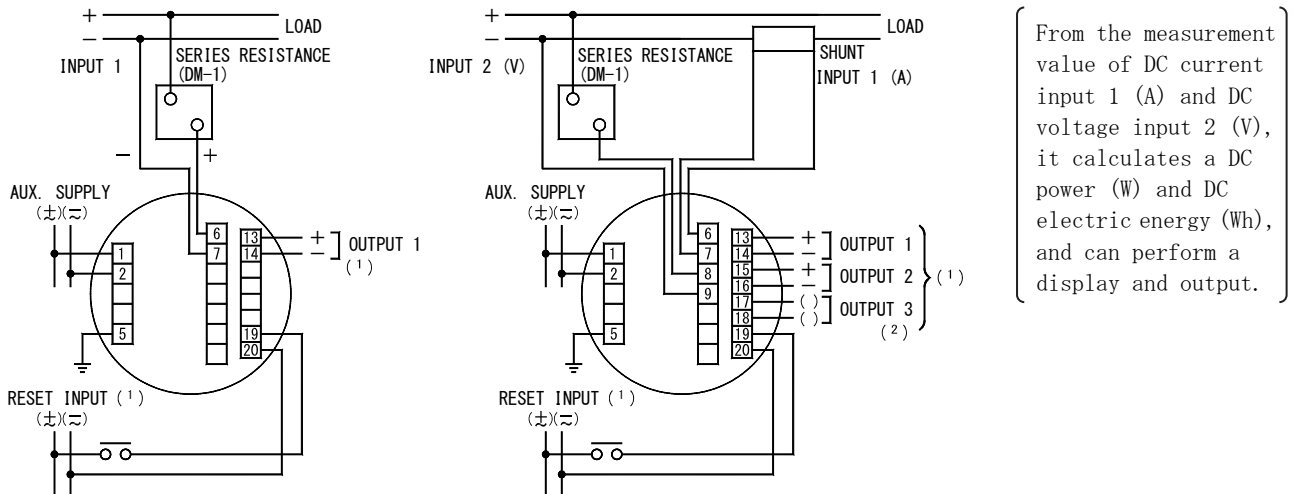

From the measurement value of DC current input 1 (A) and DC voltage input 2 (V), it calculates a DC power (W) and DC electric energy (Wh), and can perform a display and output.

Note<sup>(1)</sup> Output 1, output 2, output 3, reset input, pulse output is an option.

Note<sup>(2)</sup> Output 1 and 2 are only for analog output. Output 3 are analog output or pulse output.

[If output 3 is an analog output, it will be 17(+) and 18(-).]

The output of electric energy (Wh) is a pulse output of an output 3.



### 3.2.2 Cautions on connections

- (1) Mount the terminal cover without fail for safety after the end of connections.
- (2) Separate the input wiring and output wiring from each other without fail, and take a preventive measure against malfunction due to external noises.
- (3) Connect the grounding terminal E (No. 5 terminal) to the ground without fail for enhancing the shield effect keep the grounding resistance between the grounding terminal and the ground to be lower than 100Ω.
- (4) Keep a distance as much as possible of between this unit and the circuit breaker as well as between this unit and the relay contact signal line.
- (5) No protection is necessary for this unit even if the transmission line may be affected by an induced lightning surge or the like when transmitting an analog output to the receiver.  
Mount an about 500V arrester or the like between the line surge protector and the ground as well as between the transmission line and the ground on the receiver side for the purpose of protecting the devices on the receiver side.
- (6) If a voltage input is above 301V, it uses series-resistance DM-1.  
DM-1 is adjusted combining the meter body. Please be sure to use DM-1 of attachment.  
If two or more DM-1 in one meter are attached, please use it combining the thing suitable for an input factor.

## 4. Operation

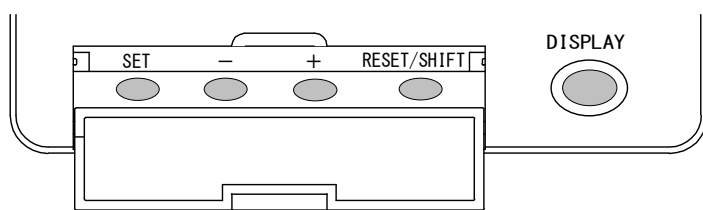

Switches	Functions
SET	By pressing this switch for longer than 3 seconds, the mode is switched from display mode to setting mode 1. <sup>(3)</sup> By pressing this switch for longer than 3 seconds together with <span style="border: 1px solid black; padding: 2px;">DISPLAY</span> switch, the mode is switched from display mode to setting mode 2. This mode can be reset to the display mode by <span style="border: 1px solid black; padding: 2px;">DISPLAY</span> switch. In case of Wh measurement, it can indicate the integrated value by enlargement. And it can check to the 3rd digit below a decimal point. Each time this switch is pressed, enlargement and reset will be repeated.
-	Flicker value can be checked. This mode can be reset to the display mode by <span style="border: 1px solid black; padding: 2px;">DISPLAY</span> switch.
+	Maximum value and minimum value can be checked. This function can be replaced with a <span style="border: 1px solid black; padding: 2px;">DISPLAY</span> switch.
RESET/SHIFT	By pressing this switch for longer than 1 seconds, reset of maximum and the minimum value can be performed.
DISPLAY	The input factor on which bar graph is displayed can be changed. Its function can be replaced with <span style="border: 1px solid black; padding: 2px;">+</span> switch.

Note<sup>(3)</sup> In Wh measurement, a press on a SET switch indicates the integrated value by enlargement.

#### ● Convenient functions

Even if the unit is stopped operating, it returns to the display mode in 10 minutes.

5. Display

(1) Example of display of input 1 circuit

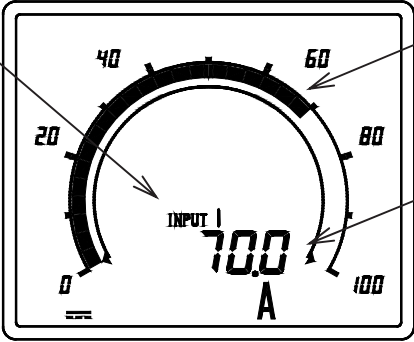
Display combination	Pattern 1 Main monitor : Input 1 (Set the INPUT display to ON.)
Display scaling	Input 1 : 0.0 to 100.0A
Display	<p><u>INPUT1</u> Measurement display symbol of input 1. During measurement, it always indicates. Indication off is possible by setting.</p>  <p><u>Bar graph display</u> [Main monitor] The measurement value of input 1 is indicated by the analog.</p> <p><u>Digital display</u> [Main monitor] The measurement value of input 1 is displayed.</p>

(2) Example of display of input 2 circuit

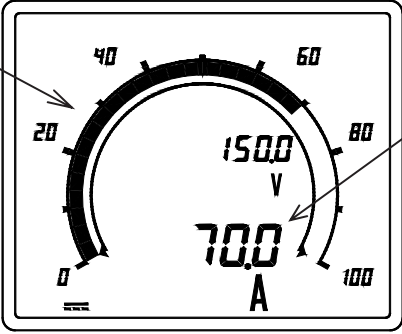
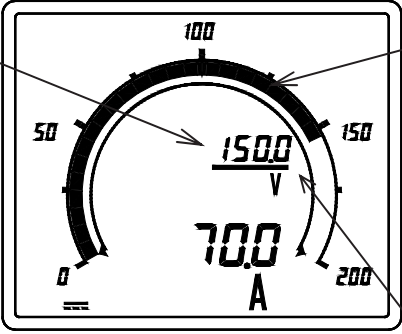
Display combination	Pattern 2 Main monitor : Input 1 , Sub-monitor (Right) : Input 2 (Set the INPUT display to auto off.)
Display scaling	Input 1 : 0.0 to 100.0A Input 2 : 0.0 to 200.0V
Display	<p>① Bar graph display of the main monitor.</p> <p><u>Bar graph display</u> [Main monitor] When it changes to "main monitor" with a <b>DISPLAY</b> switch, the measurement value of an input 1 is indicated by the analog.</p>  <p><u>Digital display</u> [Main monitor] The measurement value of input 1 is displayed.</p> <p>Press <b>DISPLAY</b> switch</p> <p>② Bar graph display of the sub-monitor (right).</p> <p><u>Digital display</u> [Sub-monitor (right)] The measurement value of input 2 is displayed.</p>  <p><u>Bar graph display</u> [Sub-monitor (right)] When it changes to "sub-monitor (right)" with a <b>DISPLAY</b> switch, the measurement value of an input 2 is indicated by the analog. An underbar indicates.</p> <p>The underbar of a sub-monitor (right) indicates.</p>

(3) Example of display of input 3 circuit

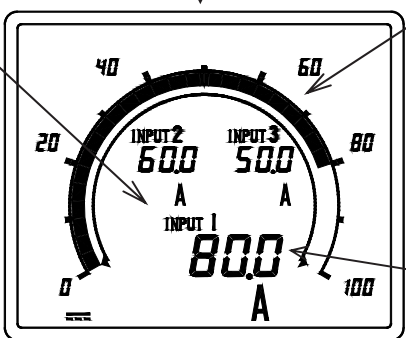
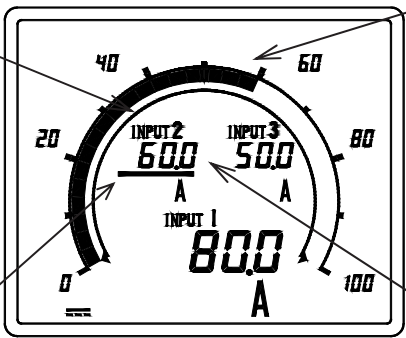
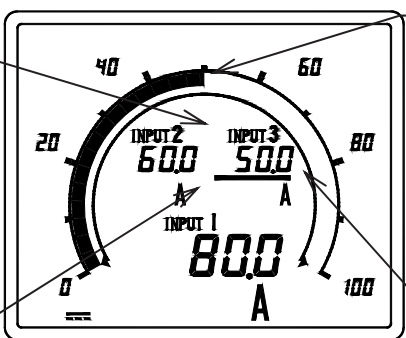
<p>Display combination</p>	<p>Pattern 1 Main monitor : Input 1 , Sub-monitor (Left) : Input 2 , sub-monitor (Right) : Input 3 (Set the INPUT display to ON.)</p>
<p>Display scaling</p>	<p>Input 1 : 0.0 to 100.0A Input 2 : 0.0 to 100.0A Input 3 : 0.0 to 100.0A } If display scaling of 3 inputs is the same</p>
<p>Display</p>	<p>① Bar graph display of main monitor.</p>  <p><u>INPUT 1</u> Measurement display symbol of input 1. During measurement, it always indicates. Indication off is possible by setting.</p> <p>Bar graph display [Main monitor] When it changes to "main monitor" with a <b>DISPLAY</b> switch, the measurement value of an input 1 is indicated by the analog.</p> <p>Digital display [Main monitor] The measurement value of input 1 is displayed.</p> <p>Press <b>DISPLAY</b> switch</p> <p>② Bar graph display of the sub-monitor (left).</p>  <p><u>INPUT 2</u> Measurement display symbol of input 2. During measurement, it always indicates. Indication off is possible by setting.</p> <p>The underbar of a sub-monitor (left) indicates.</p> <p>Bar graph display [Sub-monitor (left)] When it changes to "sub-monitor (left)" with a <b>DISPLAY</b> switch, the measurement value of an input 2 is indicated by the analog. An underbar indicates.</p> <p>Digital display [Sub-monitor (left)] The measurement value of input 2 is displayed.</p> <p>Press <b>DISPLAY</b> switch</p> <p>③ Bar graph display of the sub-monitor (right).</p>  <p><u>INPUT 3</u> Measurement display symbol of input 3. During measurement, it always indicates. Indication off is possible by setting.</p> <p>The underbar of a sub-monitor (right) indicates.</p> <p>Bar graph display [Sub-monitor (right)] When it changes to "sub-monitor (right)" with a <b>DISPLAY</b> switch, the measurement value of an input 3 is indicated by the analog. An underbar indicates.</p> <p>Digital display [Sub-monitor (right)] The measurement value of input 3 is displayed.</p> <p>Press <b>DISPLAY</b> switch</p> <p>* This is a limitation to the display pattern 1, and in order to check which input it is indicating, it is indicating "INPUT1", "INPUT2", and "INPUT3". However, Indication off is possible by setting.</p>

(4) The example of display in DC power (W) measurement

<p>Display combination</p>	<p>Pattern 7 Main monitor : DC power (W), Sub-monitor (Left) : Input 1 (A), Sub-monitor (Right) : Input 2 (V) (Set the INPUT display is AUTO OFF.)</p>	
<p>Display scaling</p>	<p>Input 1(A) : 0.0 to 100.0A Input 2(V) : 0.0 to 100.0V DC power (W) calculation value : 0.00 to 20.00kW</p>	<p>The display scaling value of DC power (W), it does automatic scaling from the display scaling value of an input 1 (A) and an input 2 (V). However, change of scaling is manually possible.</p>
<p>Display</p>	<p>① Bar graph display of main monitor.</p> <div style="display: flex; justify-content: space-between;"> <div data-bbox="379 555 699 768" style="width: 45%;"> <p><u>Bar graph display</u> [Main monitor] When it changes to "main monitor" with a <span style="border: 1px solid black; padding: 2px;">DISPLAY</span> switch, the measurement value of an DC power (W) is indicated by the analog.</p> </div> <div data-bbox="730 477 1134 835" style="width: 45%; text-align: center;"> </div> <div data-bbox="1177 645 1489 768" style="width: 45%;"> <p><u>Digital display</u> [Main monitor] The measurement value of DC power (W) is displayed.</p> </div> </div> <p style="text-align: center;">Press <span style="border: 1px solid black; padding: 2px;">DISPLAY</span> switch</p> <p>② Bar graph display of the sub-monitor (left).</p> <div style="display: flex; justify-content: space-between;"> <div data-bbox="379 1025 699 1272" style="width: 45%;"> <p><u>Digital display</u> [Sub-monitor (left)] The measurement value of input 1(A) is displayed.</p> <p>The underbar of a sub-monitor (left) indicates.</p> </div> <div data-bbox="730 1003 1134 1317" style="width: 45%; text-align: center;"> </div> <div data-bbox="1177 1025 1489 1305" style="width: 45%;"> <p><u>Bar graph display</u> [Sub-monitor (left)] When it changes to "sub-monitor (left)" with a <span style="border: 1px solid black; padding: 2px;">DISPLAY</span> switch, the measurement value of an input 1(A) is indicated by the analog. An underbar indicates.</p> </div> </div> <p style="text-align: center;">Press <span style="border: 1px solid black; padding: 2px;">DISPLAY</span> switch</p> <p>③ Bar graph display of the sub-monitor (right).</p> <div style="display: flex; justify-content: space-between;"> <div data-bbox="379 1473 699 1765" style="width: 45%;"> <p><u>Digital display</u> [Sub-monitor (right)] The measurement value of input 2(V) is displayed.</p> <p>The underbar of a sub-monitor (right) indicates.</p> </div> <div data-bbox="730 1451 1134 1765" style="width: 45%; text-align: center;"> </div> <div data-bbox="1177 1473 1489 1765" style="width: 45%;"> <p><u>Bar graph display</u> [Sub-monitor (right)] When it changes to "sub-monitor (right)" with a <span style="border: 1px solid black; padding: 2px;">DISPLAY</span> switch, the measurement value of an input 2(V) is indicated by the analog. An underbar indicates.</p> </div> </div> <p style="text-align: center;">Press <span style="border: 1px solid black; padding: 2px;">DISPLAY</span> switch</p>	

(5) The example of display in DC electric energy (Wh) measurement

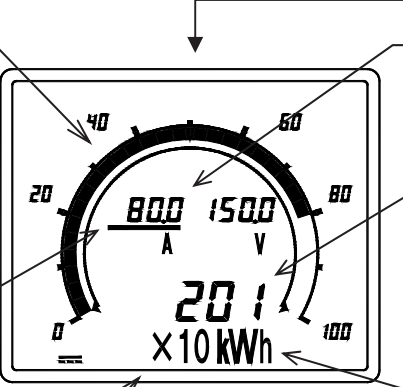
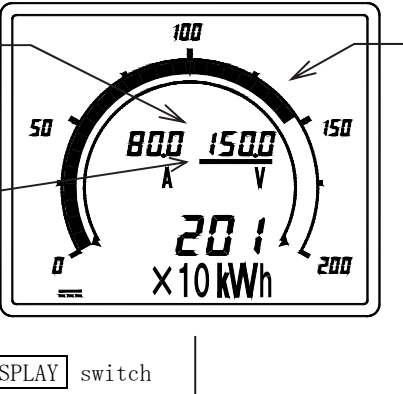
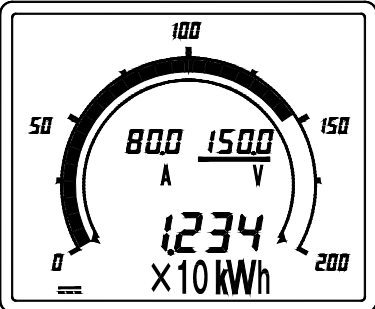
<p>Display combination</p>	<p>Pattern D Main monitor : DC electric energy (Wh), Sub-monitor (Left) : Input 1 (A), Sub-monitor (Right) : Input 2 (V) (Set the INPUT display is AUTO OFF.)</p>
<p>Display scaling</p>	<p>Input 1(A) : 0.0 to 100.0A } Calculate DC electric energy (Wh) from input 1 (A) and Input 2(V) : 0.0 to 100.0V } input 2 (V).</p>
<p>Display</p>	<p style="text-align: center;">※ Wh measurement does not indicate bar graph.</p> <p>① Bar graph display of sub-monitor (left).</p> <div style="display: flex; justify-content: space-between;"> <div style="width: 45%;"> <p><u>Bar graph display</u> [Sub-monitor (left)] When it changes to "sub-monitor" with a <b>DISPLAY</b> switch, the measurement value of an input 1(A) is indicated by the analog. An underbar indicates.</p> <p>The underbar of a sub-monitor (left) indicates.</p> <p>Multiplying factor display Appoint from <math>\times 0.1</math>, <math>\times 1</math>, <math>\times 10</math>, <math>\times 100</math>, <math>\times 1000</math>.</p> <p style="text-align: center;">Press <b>DISPLAY</b> switch</p> </div> <div style="width: 45%;"> <p><u>Digital display</u> [Sub-monitor (left)] The measurement value of input 1(A) is displayed.</p> <p><u>Digital display</u> [Main monitor] The measurement value of DC electric energy (Wh) is displayed.</p> <p>Multiplying factor (x10) and a unit (kWh) become lettering or silk printing. (Change is impossible)</p> </div> </div>  <p style="text-align: center;">Press <b>DISPLAY</b> switch</p> <p>② Bar graph display of the submonitor (right).</p> <div style="display: flex; justify-content: space-between;"> <div style="width: 45%;"> <p><u>Digital display</u> [Sub-monitor (right)] The measurement value of input 2(V) is displayed.</p> <p>The underbar of a sub-monitor (right) indicates.</p> <p style="text-align: center;">Press <b>DISPLAY</b> switch</p> </div> <div style="width: 45%;"> <p><u>Bar graph display</u> [Sub-monitor (right)] When it changes to "submonitor (right)" with a <b>DISPLAY</b> switch, the measurement value of an input 2(V) is indicated by the analog. An underbar indicates.</p> </div> </div>  <p>③ If a <b>SET</b> switch is pressed, it can check to the 3rd digit below a decimal point about DC electric energy (Wh).</p> <div style="display: flex; justify-content: space-between;"> <div style="width: 45%;">  </div> <div style="width: 45%;"> <p>Usually, a display</p> <div style="text-align: center;"> <span style="border: 1px solid black; padding: 2px;">201.234</span> <math>\times 10\text{kWh}</math> </div> <p>Enlargement display</p> </div> </div> <p>If the DC electric energy (Wh) exceeds display 9999, it returns to 0 and continues a count.</p>

## 6. Setting

### 6.1 Function table and default setting

At the case of shipment, it is a following default value. Please set up according to an operating condition. In addition, about setting products, it is shipped by the appointed set point.

Setting mode 1. Function table.

Setting No.	Function		Functional description	Default setting	Important setting	Page	
111	Display combination setting		Set the combination pattern of a digital display. By patterns 1 to 6, it can change arbitrarily the position of the digital display of a maximum of 3 circuits. By patterns 7 to C, it sets the display output of DC power (W) measurement. By patterns D to J, it sets the display output of DC electric energy (Wh) measurement.	Pattern 1	○	27 to 30	
112	Unit display setting	Input 1	Set the unit display of an input 1.	With no unit display	○	27 to 30	
113		Input 2	Set the unit display of an input 2.	With no unit display	○		
114		Input 3	Set the unit display of an input 3.	With no unit display	○		
115	INPUT display ON/OFF		Set the ON/OFF of an INPUT display. However, only the pattern 1 of display combination is effective. OFF except for pattern 1.	ON	○	27 to 30	
121H	Input 1 Flicker setting	Upper limit value	The upper limit flicker value of an input 1 measurement display is set up.	100.0 (100% of display span)	○	31 to 32	
122L		Lower limit value	The lower limit flicker value of an input 1 measurement display is set up.	0.0 (0% of display span)	○		
123		ON/OFF	When input is more than detection or less than detection setting value, this sets flicker ON/OFF of digital display.	OFF	○		
124H	Input 2 Flicker setting	Upper limit value	The upper limit flicker value of an input 2 measurement display is set up.	100.0 (100% of display span)	○	31 to 32	
125L		Lower limit value	The lower limit flicker value of an input 2 measurement display is set up.	0.0 (0% of display span)	○		
126		ON/OFF	When input is more than detection or less than detection setting value, this sets flicker ON/OFF of digital display.	OFF	○		
127H	Input 3 Flicker setting	Upper limit value	The upper limit flicker value of an input 3 measurement display is set up.	100.0 (100% of display span)	○	31 to 32	
128L		Lower limit value	The lower limit flicker value of an input 3 measurement display is set up.	0.0 (0% of display span)	○		
129		ON/OFF	When input is more than detection or less than detection setting value, this sets flicker ON/OFF of digital display.	OFF	○		
131	DISPLAY switch function change setting		Set this function when changing the <input type="checkbox"/> switch and <input type="checkbox"/> DISPLAY switch.	0	○	32	
			0				<input type="checkbox"/> DISPLAY switch : Bar graph display change
							<input type="checkbox"/> switch : Maximum and minimum value display change
			1				<input type="checkbox"/> DISPLAY switch : Maximum and minimum value display change
			<input type="checkbox"/> switch : Bar graph display change				

Setting No.	Function	Functional description	Default setting	Important setting	Page
141 ( <sup>4</sup> )	Multiplying factor setting	Set the multiplying factor.	1 (×1)		33
142P ( <sup>5</sup> )	Pulse output setting	Set the output pulse unit (kWh/pulse).	1 (kWh/pulse)		33
151 ( <sup>6</sup> )	Backlight action	Set the backlight action from ON (always-on), AUTO (auto off), and OFF (always-off).	AUTO (Auto OFF)		34
152 ( <sup>6</sup> )	Backlight brightness	Set the brightness of backlight.	3 (Middle)		34

Note(<sup>4</sup>) This can set only at the case of Wh measurement specification (display pattern D to J).

Note(<sup>5</sup>) This can set only at the case of pulse output (option) specification.

Note(<sup>6</sup>) This can set only at the case of white backlight specification.

#### Setting mode 2. Function table.

Setting No.	Function		Functional description	Default setting	Important setting	Page
211b	Input 1 Display scaling setting	BIAS	Display bias value setting of an input 1	0.0	○	36 37
212F		MAX.	Display max. value setting of an input 1	100.0	○	
213P		Decimal point	Decimal point setting of an input 1	□□□.□	○	
214		COS $\phi$ , Hz, var	COS $\phi$ , Hz, var display scaling setting of input 1	0 (Standard scale)	○	
215b	Input 2 Display scaling setting	BIAS	Display bias value setting of an input 2	0.0	○	36 37
216F		MAX.	Display max. value setting of an input 2	100.0	○	
217P		Decimal point	Decimal point setting of an input 2	□□□.□	○	
218		COS $\phi$ , Hz, var	COS $\phi$ , Hz, var display scaling setting of input 2	0 (Standard scale)	○	
219b	Input 3 Display scaling setting	BIAS	Display bias value setting of an input 3	0.0	○	36 37
21AF		MAX.	Display max. value setting of an input 3	100.0	○	
21bP		Decimal point	Decimal point setting of an input 3	□□□.□	○	
21C		COS $\phi$ , Hz, var	COS $\phi$ , Hz, var display scaling setting of input 3	0 (Standard scale)	○	
221b	Input 1 Input calibration	BIAS	Zero adjustment of the input 1 (INPUT1) at the case of a bias input can be performed. Display and output are adjusted simultaneously.	0.00		38
222F		SPAN	The input 1 display and output span adjustment at the case of an input apply can be performed. The effective if a display wants to synchronize with other meter.	0.00		
223b	Input 2 Input calibration	BIAS	Zero adjustment of the input 2 (INPUT2) at the case of a bias input can be performed. Display and output are adjusted simultaneously.	0.00		38
224F		SPAN	The input 2 display and output span adjustment at the case of an input apply can be performed. The effective if a display wants to synchronize with other meter.	0.00		
225b	Input 3 Input calibration	BIAS	Zero adjustment of the input 3 (INPUT3) at the case of a bias input can be performed. Display and output are adjusted simultaneously.	0.00		38
226F		SPAN	The input 3 display and output span adjustment at the case of an input apply can be performed. The effective if a display wants to synchronize with other meter.	0.00		

Setting No.	Function		Functional description	Default setting	Important setting	Page
231	Input sensitivity (Bar graph Full scale)	Input 1	The full scale of input 1 bar graph display is changed.	100		39
232		Input 2	The full scale of input 2 bar graph display is changed.	100		
233		Input 3	The full scale of input 3 bar graph display is changed.	100		
241A <sup>(7)</sup>	Output factor	Output 1	Can be select which input element to output to output 1 (OUTPUT1).	Input 1 (INPUT1)	○	40
242A <sup>(7)</sup>		Output 2	Can be select which input element to output to output 2 (OUTPUT2).	Input 2 (INPUT2)	○	
243A <sup>(7)</sup>		Output 3	Can be select which input element to output to output 3 (OUTPUT3).	Input 3 (INPUT3)	○	
251b <sup>(7)</sup>	Output 1 calibration	BIAS	Output 1 (OUTPUT1) zero adjustment at the case of a bias input can be performed.	0.00		41
252F <sup>(7)</sup>		SPAN	Span adjustment of an output 1 can be performed at the case of an input apply. Up to 99% can be set. Sensitivity change of an output can also be performed.	0.00		
253b <sup>(7)</sup>	Output 2 calibration	BIAS	Output 2 (OUTPUT2) zero adjustment at the case of a bias input can be performed.	0.00		41
254F <sup>(7)</sup>		SPAN	Span adjustment of an output 2 can be performed at the case of an input apply. Up to 99% can be set. Sensitivity change of an output can also be performed.	0.00		
255b <sup>(7)</sup>	Output 3 calibration	BIAS	Output 3 (OUTPUT3) zero adjustment at the case of a bias input can be performed.	0.00		41
256F <sup>(7)</sup>		SPAN	Span adjustment of an output 3 can be performed at the case of an input apply. Up to 99% can be set. Sensitivity change of an output can also be performed.	0.00		
261	Low input cut	Input 1	In case of 0 to N, -N to 0 to N (example : -100 to 0 to 100) of display scaling.	OFF		42
262		Input 2	It does below 0.5% of inputs to 0 display. And, it makes analog output into a bias value.	OFF		
263		Input 3	'-N' to 0 to N (example : -10 to 0 to 100) and -N to 0 do not function.	OFF		
271	Display dead band	Input 1	In case the input is unsteady, this setting can drop the sensitivity of a display.	0.0		43
272		Input 2		0.0		
273		Input 3		0.0		
281	Measurement display ON/OFF	Input 1	ON/OFF of an input 1 measurement display is set up.	ON		44
282		Input 2	ON/OFF of an input 2 measurement display is set up.	ON		
283		Input 3	ON/OFF of an input 3 measurement display is set up.	ON		
284		Wh <sup>(8)</sup>	ON/OFF of an Wh measurement display is set up.	ON		
291	Returns to default setting		Initializes the all settings.	—		45

Note<sup>(7)</sup> This can set only at the case of analog output (option) specification.

Note<sup>(8)</sup> This can set only at the case of Wh measurement specification (display pattern D to J).

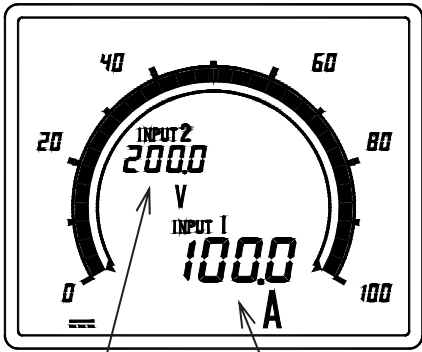
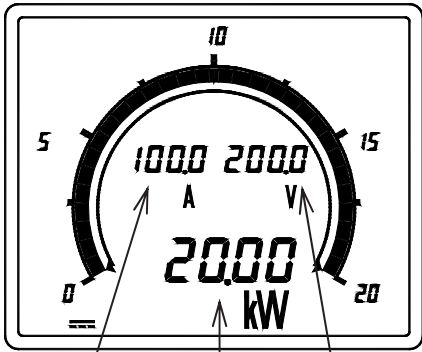

6.2 Example of setting function

<p>Functional example ①</p>	<p>DC power measurement (Input DC current to input 1 and DC voltage to input 2.)                  Input 1(A) : 0 to 60mV , Display : 0.0 to 100.0A } <u>DC power (W) display : 0.00 to 20.00kW</u>                  Input 2(V) : 0 to 200V , Display : 0.0 to 200.0V }                  However, only input 2 circuit and 3 circuit specification are effective.                  Input 1 circuit specifications cannot be set.</p>	
<p>Setting function</p>	<p>Please use "display combination setting" (setting No.111) in the setting mode 1.                  → If it is set as pattern 7 to C, it will measure DC power (W).</p>	
<p>Function explanation</p>	<p>Before use (Setting : Pattern 1)                  Example. 2 input specification</p>  <p>Input 2 : DC voltage                  Input 1 : DC current</p>	<p>After use (Setting : Pattern 7)                  Example. 2 input specification                  + DC power measurement</p>  <p>Input 1 : DC current    Input 2 : DC voltage                  DC power</p> <p>The scale of DC power (W), it does automatic scaling from the scale of an input 1 (A) and an input 2 (V). However, change of scale is manually possible.</p>

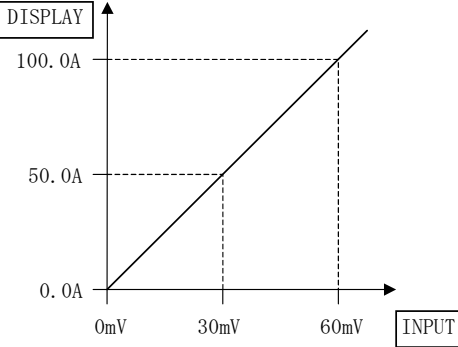
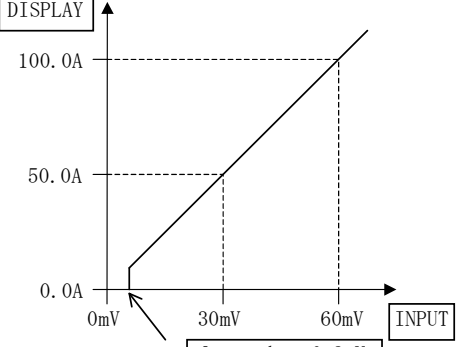
<p>Functional example ②</p>	<p>Input : 0 to 60mV, Display : 0.0 to 100.0A.                  If indicated value is fixed to 0 at the case of the fine input near 0mV of inputs.</p>	
<p>Setting function</p>	<p>Please use "low input cut setting" (setting No.261 to 263) in the setting mode 2.                  → Indicated value is fixed to 0 at the case of the minute electric input equivalent to less than 0.5% of an input span.                  (Example. In case of 0 to 60mV, less than 0.3mV → display : 0.0A)                  However, effective only at the case of display scaling 0 to N and -N to 0 to N (example : -100 to 0 to 100). For -N' to 0 to N (example : -10 to 0 to 100) and -N to 0, this setting does not work.</p>	
<p>Function explanation</p>	<p>Before ( Setting : OFF )</p>  <p>Input : 0.3mV → Display : 0.5A                  Input : 0mV → Display : 0.0A</p>	<p>After ( Setting : ON )</p>  <p>Input : 0.3mV → Display : 0.0A                  Input : 0mV → Display : 0.0A</p>

<p>Functional example ③</p>	<p>Input : <math>\pm 60\text{mV}</math> , Display : <math>\pm 100.0\text{A}</math>                  If you want to fix indicated value to 0 at the case of the minute electric input near 0mV of inputs.</p>	
<p>Setting function</p>	<p>Please use "low input cut setting" (setting No. 261 to 263) in the setting mode 2.                  → Indicated value is fixed to 0 at the case of the minute electric input equivalent to less than 0.5% of an input span.                  (Example. In case of <math>\pm 60\text{mV}</math>, less than <math>\pm 0.3\text{mV}</math> → display : 0.0A)                  However, effective only at the case of display scaling 0 to N and -N to 0 to N (example : -100 to 0 to 100). For -N' to 0 to N (example : -10 to 0 to 100) and -N to 0, this setting does not work.</p>	
<p>Function explanation</p>	<p style="text-align: center;">Before ( Setting : OFF )</p> <p style="text-align: center;">Input : 0.3mV → Display : 0.5A                  Input : 0mV → Display : 0.0A</p>	<p style="text-align: center;">After ( Setting : ON )</p> <p style="text-align: center;">Input : Less than 0.5mV → Display : 0.0A                  Input : 0mV → Display : 0.0A</p>

<p>Functional example ④</p>	<p>Used to suppress the variation in the indicated value by input variation.</p>	
<p>Setting function</p>	<p>Please use "Display dead band setting" (setting No. 271 to 273) in the setting mode 2.                  → The sensitivity of a display is dropped and the variation in indicated value is suppressed.                  The setting range becomes 0.0% to 2.0% (0.1% step).</p>	
<p>Function explanation</p>	<p style="text-align: center;">Before ( Setting : 0.0% )</p>	<p style="text-align: center;">After ( Setting : 1.0% )</p>

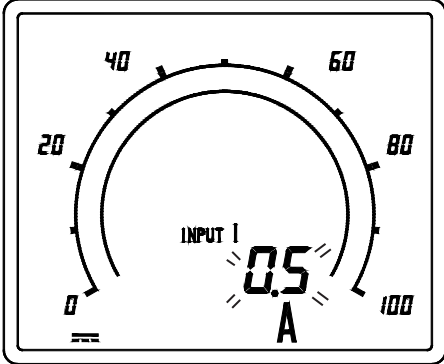
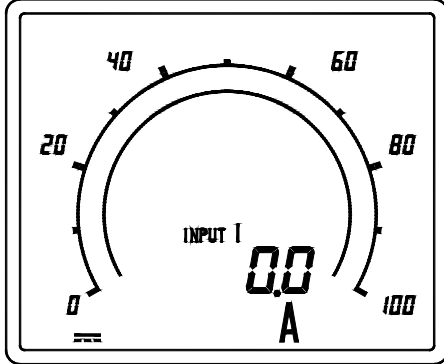
<p>Functional example ⑤</p>	<p>In case the span or zero has shifted at the indicated value.</p>	
<p>Setting function</p>	<p>Please use "input calibration setting" (setting No. 221b to 226F) in the setting mode 2.          → A span or zero is adjusted of indicated value. The setting range becomes -9.99% to 9.99% of an input span (0.01% step).</p>	
<p>Function explanation</p>	<p style="text-align: center;">Before ( Setting : BIAS 0.00%)</p> <div style="text-align: center;">  </div> <p>Example) At the case of 0mV of inputs, it is displayed as place 0.5A whose indicated value is 0.0A.</p>	<p style="text-align: center;">After ( Setting : BIAS -0.50%)</p> <div style="text-align: center;">  </div> <p>Example) At the case of 0mV of inputs, indicated value can be adjusted to 0.0A.</p>

### 6.3 Setting table

Each parenthesized number shows a setting number and this number is displayed on the setting screen.  
 <Caution> There is a setting item excepted by input circuits or measurement display ON/OFF setting.

(1) Setting of display combination and unit display.

Items	Setting and operation procedures	Page
Set the display combination. (111)	Press <b>SET</b> for longer than 3 seconds → (111) Select the display combination pattern by <b>+</b> and <b>-</b> → Press <b>SET</b> → Selected display combination pattern is entered → Press <b>DISPLAY</b> → Returns to display mode	27 to 30
Set the unit display of input 1 (112) ( <sup>9</sup> )	Press <b>SET</b> for longer than 3 seconds → Press <b>RESET/SHIFT</b> → (111) (112) Select the unit by <b>+</b> and <b>-</b> → Press <b>SET</b> → Selected unit is entered → Press <b>DISPLAY</b> → Returns to display mode	27 to 30
Set the unit display of input 2 (113) ( <sup>9</sup> )	Press <b>SET</b> for longer than 3 seconds → Press <b>RESET/SHIFT</b> → (111) (112) Press <b>RESET/SHIFT</b> → Select the unit by <b>+</b> and <b>-</b> → Press <b>SET</b> → (113) Selected unit is entered → Press <b>DISPLAY</b> → Returns to display mode	27 to 30
Set the unit display of input 3 (114) ( <sup>9</sup> )	Press <b>SET</b> for longer than 3 seconds → Press <b>RESET/SHIFT</b> → (111) (112) Press <b>RESET/SHIFT</b> → Press <b>RESET/SHIFT</b> → Select the unit by <b>+</b> and <b>-</b> → (113) (114) Press <b>SET</b> → Selected unit is entered → Press <b>DISPLAY</b> → Returns to display mode	27 to 30
Set the INPUT display ON/OFF (115) ( <sup>10</sup> )	Press <b>SET</b> for longer than 3 seconds → Press <b>RESET/SHIFT</b> → Press <b>RESET/SHIFT</b> → (111) (112) → Press <b>RESET/SHIFT</b> → Press <b>RESET/SHIFT</b> → (113) (114) (115) Select an INPUT display ON or OFF by <b>+</b> and <b>-</b> → Press <b>SET</b> → Selected ON/OFF setting is entered → Press <b>DISPLAY</b> → Returns to display mode	27 to 30

Note(<sup>9</sup>) While doing COS<sup>φ</sup> and Hz and var display setting, there is a setting item excepted.

Note(<sup>10</sup>) Only the display combination pattern 1 is effective. Setting is excepted except pattern 1.

(2) Flicker setting

Items	Setting and operation procedures	Page
Setting of upper limit flicker value of input 1. (121H)	Press <b>SET</b> for longer than 3 seconds → Press <b>+</b> and <b>RESET/SHIFT</b> together → (111) (121H) Select an upper limit flicker value by <b>+</b> and <b>-</b> → Press <b>SET</b> → Selected upper limit flicker value is entered → Press <b>DISPLAY</b> → Returns to display mode	31, 32
Setting of lower limit flicker value of input 1. (122L)	Press <b>SET</b> for longer than 3 seconds → Press <b>+</b> and <b>RESET/SHIFT</b> together → (111) (121H) Press <b>RESET/SHIFT</b> → Select an lower limit flicker value by <b>+</b> and <b>-</b> → (122L) Press <b>SET</b> → Selected lower limit flicker value is entered → Press <b>DISPLAY</b> → Returns to display mode	31, 32
Setting of input 1 flicker ON/OFF. (123)	Press <b>SET</b> for longer than 3 seconds → Press <b>+</b> and <b>RESET/SHIFT</b> together → (111) (121H) Press <b>RESET/SHIFT</b> → Press <b>RESET/SHIFT</b> → (122L) (123) Select an flicker ON or flicker OFF by <b>+</b> and <b>-</b> → Press <b>SET</b> → Selected flicker ON/OFF setting is entered → Press <b>DISPLAY</b> → Returns to display mode	31, 32

(3) Functional exchange setting of **DISPLAY** and **+** switch.

Items	Setting and operation procedures	Page
Changes the function of <b>DISPLAY</b> switch and <b>+</b> switch. (131)	Press <b>SET</b> for longer than 3 seconds → Press <b>+</b> and <b>RESET/SHIFT</b> together → (111) (121H) Press <b>+</b> and <b>RESET/SHIFT</b> together → Select an function by <b>+</b> and <b>-</b> → (131) Press <b>SET</b> → Selected function is entered → Press <b>DISPLAY</b> → Returns to display mode (Explanation) Display in setting 0: <b>DISPLAY</b> Bar graph display change. <b>+</b> Maximum value, minimum value display change. Display in setting 1: <b>DISPLAY</b> Maximum value, minimum value display change. <b>+</b> Bar graph display change.	32

## (4) Backlight setting

Items	Setting and operation procedures	Page
Setting of backlight action. (151)	Press <b>SET</b> for longer than 3 seconds $\rightarrow$ Press <b>+</b> and <b>RESET/SHIFT</b> together $\rightarrow$ (111) (121H) Press <b>+</b> and <b>RESET/SHIFT</b> together $\rightarrow$ Press <b>+</b> and <b>RESET/SHIFT</b> together $\rightarrow$ (131) (141) <sup>(11)</sup> Press <b>+</b> and <b>RESET/SHIFT</b> together $\rightarrow$ Select an backlight action by <b>+</b> and <b>-</b> $\rightarrow$ (151) Press <b>SET</b> $\rightarrow$ Selected backlight action is entered $\rightarrow$ Press <b>DISPLAY</b> $\rightarrow$ Returns to display mode	34
Setting of backlight brightness. (152)	Press <b>SET</b> for longer than 3 seconds $\rightarrow$ Press <b>+</b> and <b>RESET/SHIFT</b> together $\rightarrow$ (111) (121H) Press <b>+</b> and <b>RESET/SHIFT</b> together $\rightarrow$ Press <b>+</b> and <b>RESET/SHIFT</b> together $\rightarrow$ (131) (141) <sup>(11)</sup> Press <b>+</b> and <b>RESET/SHIFT</b> together $\rightarrow$ Press <b>RESET/SHIFT</b> $\rightarrow$ (151) (152) Select an backlight brightness by <b>+</b> and <b>-</b> $\rightarrow$ Press <b>SET</b> $\rightarrow$ Selected backlight brightness is entered $\rightarrow$ Press <b>DISPLAY</b> $\rightarrow$ Returns to display mode	34

Note<sup>(11)</sup> At the case of Wh measurement specification.

## (5) Display scaling setting

Items	Setting and operation procedures	Page
Setting of input 1 bias value. (211b) <sup>(12)</sup>	Press <b>SET</b> and <b>DISPLAY</b> together for longer than 3 seconds $\rightarrow$ (211b) Setting an bias value by <b>+</b> and <b>-</b> $\rightarrow$ Press <b>SET</b> $\rightarrow$ Setting bias value is entered $\rightarrow$ Press <b>DISPLAY</b> $\rightarrow$ Returns to display mode	36, 37
Setting of input 1 max. value. (212F) <sup>(12)</sup>	Press <b>SET</b> and <b>DISPLAY</b> together for longer than 3 seconds $\rightarrow$ (211b) Press <b>RESET/SHIFT</b> $\rightarrow$ Setting an max. value by <b>+</b> and <b>-</b> $\rightarrow$ Press <b>SET</b> $\rightarrow$ (212F) Setting max. value is entered $\rightarrow$ Press <b>DISPLAY</b> $\rightarrow$ Returns to display mode	36, 37
Setting of input 1 decimal point position. (213P) <sup>(12)</sup>	Press <b>SET</b> and <b>DISPLAY</b> together for longer than 3 seconds $\rightarrow$ Press <b>RESET/SHIFT</b> (211b) $\rightarrow$ Press <b>RESET/SHIFT</b> $\rightarrow$ Setting an decimal point position by <b>+</b> and <b>-</b> $\rightarrow$ (212F) (213P) Press <b>SET</b> $\rightarrow$ Setting decimal point position is entered $\rightarrow$ Press <b>DISPLAY</b> $\rightarrow$ Returns to display mode	36, 37
Setting of input 1 COS $\varphi$ , Hz, var. (214)	Press <b>SET</b> and <b>DISPLAY</b> together for longer than 3 seconds $\rightarrow$ Press <b>RESET/SHIFT</b> (211b) $\rightarrow$ Press <b>RESET/SHIFT</b> $\rightarrow$ Press <b>RESET/SHIFT</b> $\rightarrow$ (212F) (213P) (214) Select an COS $\varphi$ , Hz, var by <b>+</b> and <b>-</b> $\rightarrow$ Press <b>SET</b> $\rightarrow$ Selected COS $\varphi$ , Hz, var is entered $\rightarrow$ Press <b>DISPLAY</b> $\rightarrow$ Returns to display mode	36, 37

Note<sup>(12)</sup> The bias value and max. value and decimal-point position setting (211b to 213P) of an input 1 is excepted, at the case of COS $\varphi$ , Hz, var display (214) setting of input 1.

### 6.4 Measurement display-mode in detail explanation

■ If a power supply is put into this product, it will become a measurement display mode.

Digital display section

[Main monitor, Submonitor (left), Submonitor (right)]

The measurement display of three factors can be performed simultaneously.

[If display position is changed. To the setting mode 1.]

• Input 2 (INPUT2), input 3 (INPUT3), are different by the number of input circuits.

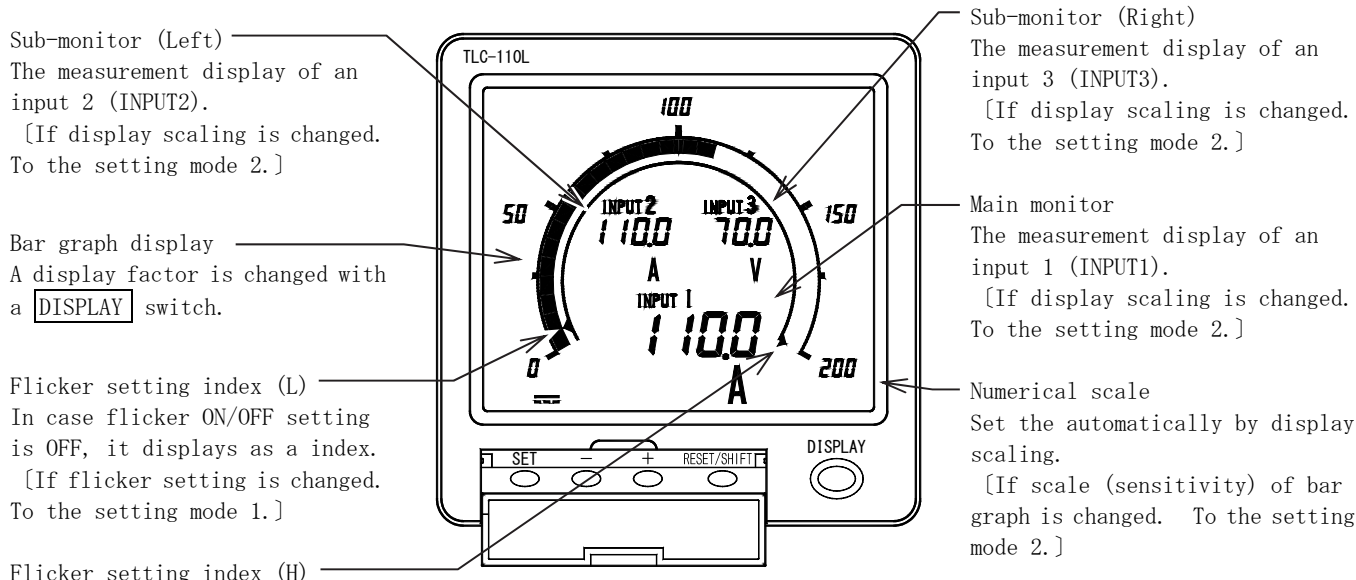

■ Switch operation from a measurement display mode.

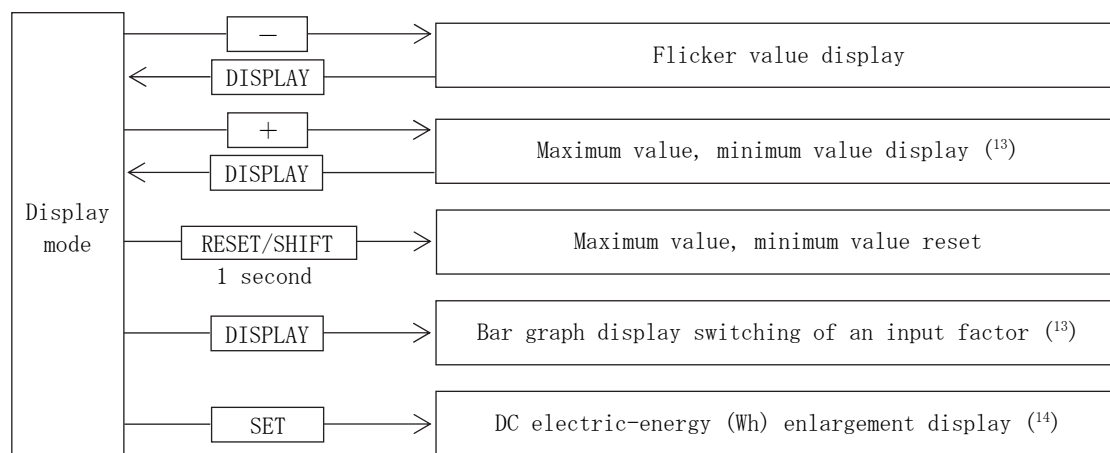

Note<sup>(13)</sup> If it is made the next setting by "DISPLAY switch-function exchange setting" and DISPLAY is pressed, the maximum value and the minimum value will indicate.

[+]: Bar graph display change. [DISPLAY]: Maximum value, minimum value display change.

Note<sup>(14)</sup> Switch operation is possible only for Wh measurement specification (display pattern D to J).

- By continuing pressing a SET switch for 3 seconds, it becomes the setting mode 1. ⇒ 26 pages
- Press and hold the SET switch and DISPLAY switch at the same time for 3 seconds or more to enter setting mode 2. ⇒ 35 pages

<Caution> There is a display item excepted by the number of input circuits or measurement display ON/OFF setting.

- In case of input 1 circuit specification, there is no display item of input 2 and input 3.
- In case of input 2 circuit specification, there is no display item of input 3.
- Please keep in mind that not all measurement values display in case a measurement display is OFF altogether.

Operation from a measurement display mode

(1) Flicker value display

The check of the flicker value of an input factor can be performed.

<p>Display</p>	
<p>Operation</p>	<p>Whenever it presses a <input type="checkbox"/> switch from a display mode, it indicates the upper limit and lower limit flicker value of an input factor.</p>
<p>Reset method</p>	<p>Press the <input type="checkbox"/> DISPLAY switch or returns to a measurement display mode by no operating it for 10 seconds.</p>
<p>Display screen</p>	<ul style="list-style-type: none"> <li>·The upper limit flicker-value display of an input 1.</li> <li>·The lower limit flicker-value display of an input 1.</li> <li>·The display in the state where the flicker was exceeded.</li> </ul> <p>Upper limit. Setting index.      Setting index. Lower limit.      Setting index is not displayed.</p> <div style="display: flex; justify-content: space-around;"> <div style="text-align: center;"> <p>Input factor. Upper limit flicker value.</p> </div> <div style="text-align: center;"> <p>Lower limit flicker value.</p> </div> <div style="text-align: center;"> <p>OFF : When a flicker value is exceeded.</p> </div> </div>



(2) Maximum value, minimum value display

The check of the maximum value and minimum value of an input factor can be performed.  
 The value is held even if maximum value and the minimum value turn off a power supply.

<p>Display</p>	
<p>Operation</p>	<p>Whenever it presses <input type="checkbox"/> switch from a display mode, the maximum and the minimum value of an input factor are displayed.              It judges value with a value including polarity, for the maximum value and minimum value.              Example) In -10.0A and 5.0A, the maximum value is set to 5.0A and the minimum value is set to -10.0A.</p> <p>Note<sup>(15)</sup> If it is made the next setting by "DISPLAY switch-function exchange setting" and <input type="checkbox"/> is pressed, the maximum value and the minimum value will indicate.  <input type="checkbox"/> : Bar graph display change. <input type="checkbox"/> : Maximum value, minimum value display change.</p>
<p>Reset method</p>	<p>Presses the <input type="checkbox"/> switch or returns to a measurement display mode by no operating it for 10 minutes.</p>
<p>Display screen</p>	<p>•Maximum value display of input 1    •Minimum value display of input 1</p> <div style="display: flex; justify-content: space-around;"> <div style="text-align: center;"> <p>Maximum value display [最大]</p> <p>Maximum value</p> </div> <div style="text-align: center;"> <p>Minimum value display [最小]</p> <p>Minimum value</p> </div> </div> <p>The maximum and the minimum are displayed in Japanese.  <input type="checkbox"/> : Maximum  <input type="checkbox"/> : Minimum</p>

In case of Wh measurement, it can check the maximum value and the minimum value about display factors other than Wh.

(3) Maximum and minimum value reset.

The maximum and the minimum holding value of an input factor are reset.

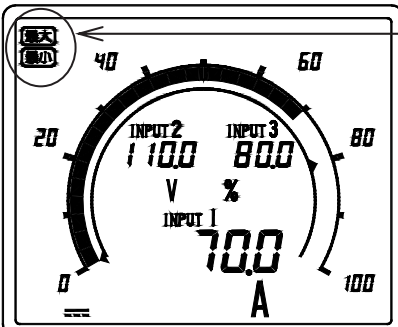
Reset process	<div style="display: flex; align-items: center; gap: 10px;"> <div style="border: 1px solid black; padding: 5px;">Display mode</div> <div style="text-align: center;">             RESET/SHIFT              Pushes more than              1 second.         </div> <div style="border: 1px solid black; padding: 5px;">Maximum value and minimum value reset of all input factors</div> </div>
Reset method	During a display mode or maximum and minimum value display, a <span style="border: 1px solid black; padding: 2px;">RESET/SHIFT</span> switch is pressed for the more than 1 seconds. The maximum and the minimum holding value of all input factors are reset.
After reset	Maximum value and minimum value are in agreement with the present input value after reset.
Screen display (Pattern 1)	<p>• Maximum value and minimum value reset display</p> <div style="display: flex; align-items: flex-start;">  <div style="margin-left: 20px;"> <p>A <span style="border: 1px solid black; padding: 2px;">RESET/SHIFT</span> switch is pressed more than 1 second. Flashing the <span style="border: 1px solid black; padding: 2px;">最大</span> (maximum) and <span style="border: 1px solid black; padding: 2px;">最小</span> (minimum) for 3 seconds simultaneously.</p> <p>The maximum and the minimum are displayed in Japanese.</p> <p><span style="border: 1px solid black; padding: 2px;">最大</span> : Maximum  <span style="border: 1px solid black; padding: 2px;">最小</span> : Minimum</p> </div> </div>

(4) Bar graph display change

The input factor that carries out a bar graph display can be changed.

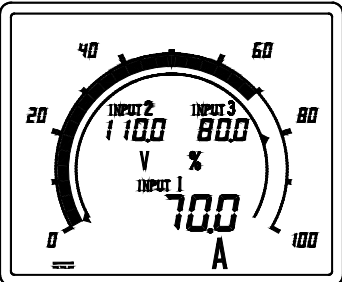
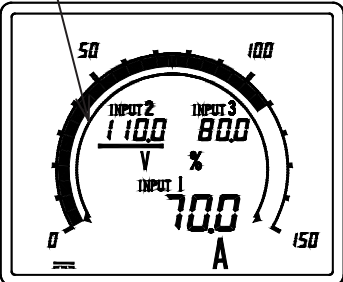
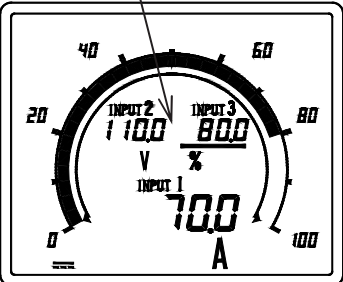
Display change process	<div style="border: 1px dashed black; padding: 10px; text-align: center;"> <p>(16)</p> <p>DISPLAY</p> <pre>             graph LR             A[Bar graph display of main monitor] -- "(16) DISPLAY" --&gt; B[Bar graph display of sub-monitor (left)]             B -- "(16) DISPLAY" --&gt; C[Bar graph display of sub-monitor (right)]             C -- "(16) DISPLAY" --&gt; A             </pre> </div>		
Display change method	<p>Whenever press the <span style="border: 1px solid black; padding: 2px;">DISPLAY</span> switch in a display mode, the bar graphical representation of an input factor changes.</p> <p>Note<sup>(16)</sup> If it is made the next setting by "<span style="border: 1px solid black; padding: 2px;">DISPLAY</span> switch-function exchange setting" and <span style="border: 1px solid black; padding: 2px;">+</span> is pressed, the bar graphical representation of an input factor changes.</p> <p><span style="border: 1px solid black; padding: 2px;">+</span> : Bar graph display change. <span style="border: 1px solid black; padding: 2px;">DISPLAY</span> : Maximum value, minimum value display change.</p>		
Screen display (Pattern 1)	<p>• Bar graph display of main monitor</p> 	<p>• Bar graph display of sub-monitor (left)</p> <p>Underbar lighting of a sub-monitor (left)</p> 	<p>• Bar graph display of sub-monitor (right)</p> <p>Underbar lighting of a sub-monitor (right)</p> 

Wh measurement does not indicate bar graph.

## 6.5 Setting detail explanatory

### 6.5.1 Setting mode 1

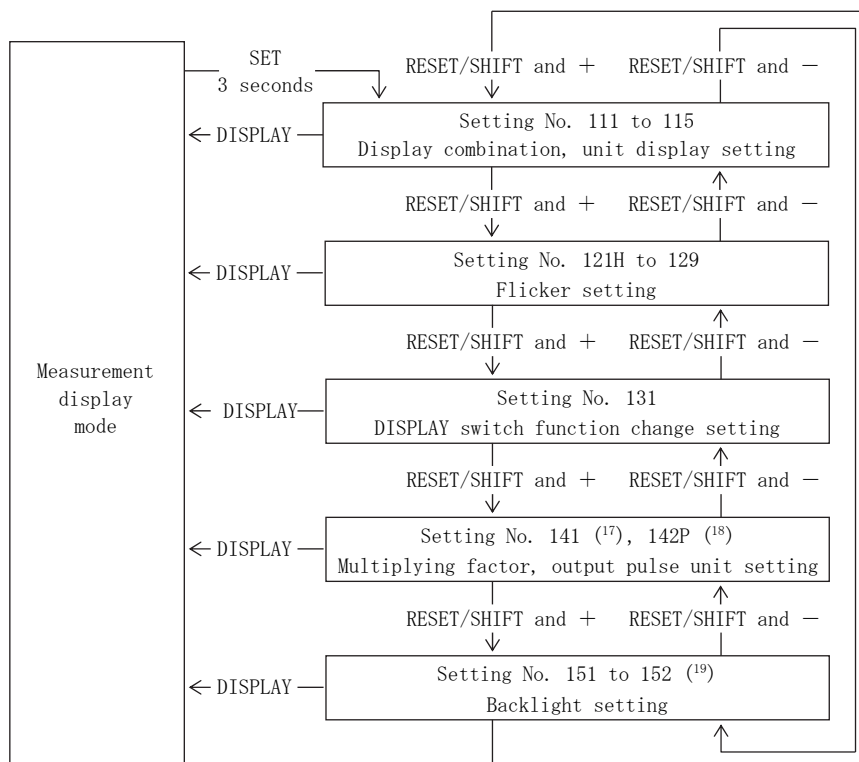

If a **SET** switch is pressed for by continuation more than 3 seconds, it will become the setting mode 1 from a display mode.

It moves a setting item with **RESET/SHIFT** and **+** switch (or **RESET/SHIFT** and **-** switch).

If a **DISPLAY** switch is pressed, it will return to a display mode.

If **+** and **-** switches are pressed together for longer than 3 seconds during setting, the current set values only are reset to the default settings.

<Caution> There is a display item excepted by the number of input circuits or measurement display ON/OFF setting.

- In case of input 1 circuit specification, there is no display item of input 2 and input 3.
- In case of input 2 circuit specification, there is no display item of input 3.
- Please keep in mind that not all measurement values display in case a measurement display is OFF altogether.

Note<sup>(17)</sup> Only Wh measurement specification (display pattern D to J) can be set.

Note<sup>(18)</sup> Only pulse output (option) specifications can be set.

Note<sup>(19)</sup> Only white backlight specifications can be set.

(1) Display combination, Unit display setting (Setting No. 111 to 115)

Display combination and unit display of input element can be set.

And, it can perform setting which erases a display of INPUT.

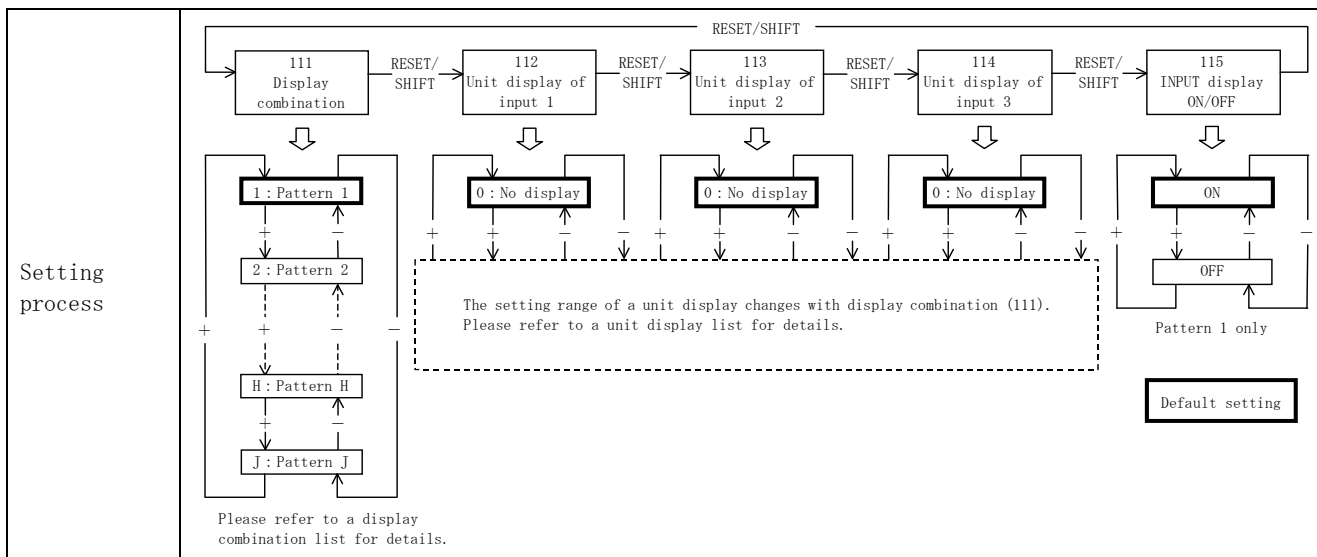

Setting item	Setting No.	Contents of setting	Setting value possible range
		111	Display combination setting
	112	Unit display setting of an input 1.	Pattern 1, 2 0 to 17 (Main monitor)
			Pattern 3 to 6 0 to 12 (Sub-monitor)
			Pattern 7 to J 0 to 4 (Main monitor, sub-monitor)
	113	Unit display setting of an input 2.	Pattern 3, 4 0 to 17 (Main monitor)
			Pattern 1, 2, 5, 6 0 to 12 (Sub-monitor)
			Pattern 7 to J 0 to 4 (Main monitor, sub-monitor)
	114	Unit display setting of an input 3.	Pattern 5, 6 0 to 17 (Main monitor)
			Pattern 1 to 4 0 to 12 (Sub-monitor)
			Pattern 7, 8 0, 5 to 7 (Main monitor)
		Pattern 9 to J 0 (Sub-monitor)	
	115	INPUT display ON/OFF setting	ON/OFF

Setting method	Setting display	Setting value change	Update of setting value
		Setting mode 1 is selected by pressing <b>SET</b> switch for longer than 3 seconds. For shifting to the item of display combination setting and unit display setting, press <b>+</b> and <b>RESET/SHIFT</b> or <b>-</b> and <b>RESET/SHIFT</b> together. Whenever it presses <b>RESET/SHIFT</b> switch, setting item changes. Only the pattern 1 of INPUT display ON/OFF setting is effective. Setting is excepted except pattern 1. By display scaling setting in the setting mode 2, unit display setting (112 to 114) of an input factor which is doing COSφ (and Hz, and var) display setting is excepted.	If a <b>+</b> switch or <b>-</b> switch is pressed, the set value will change.

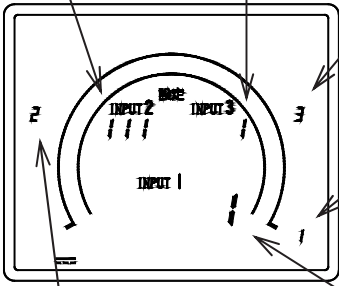
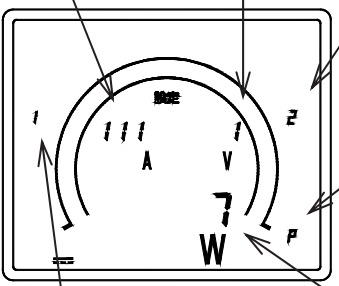
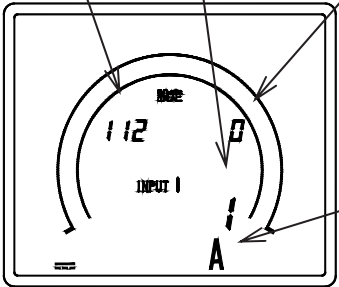
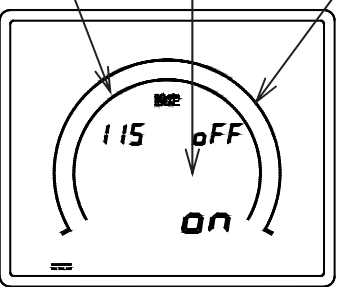
<p>Setting method</p>	<p>Return to default setting</p>	<p>If <math>\oplus</math> and <math>\ominus</math> switches are pressed together for longer than 3 seconds during setting, the present set values only are reset to the default setting values.</p> <ul style="list-style-type: none"> <li>If it returns to a pattern 1 (default setting) from pattern 7 to J.             <ol style="list-style-type: none"> <li>Stops measurement of DC power (W) and DC electric energy (Wh) at the case of input 2 circuit specification. And, an output is OFF if the output factor is set as DC power.</li> <li>In case of input 3 circuit specification, it changes from measurement of an input 3 to measurement of DC power. A scale of input 3 is a scale at the time of the DC electricity measurement. Please be careful.</li> </ol> </li> </ul>
<p>Reset method</p>	<p>Press the <b>DISPLAY</b> switch or returns to a measurement display mode by no operating it for 10 seconds.</p>	
<p>Display</p>	<div style="display: flex; justify-content: space-between;"> <div style="width: 48%;"> <p>• Display combination setting In the case of a pattern 1.</p> <p>Setting No.      Current setting</p>  <p>Indicates an input 2 on a sub-monitor (left).</p> <p>Indicates an input 3 on a sub-monitor (right).</p> <p>Indicates an input 1 on the main monitor.</p> <p>New setting</p> </div> <div style="width: 48%;"> <p>In the case of a pattern 7.</p> <p>Setting No.      Current setting</p>  <p>Indicates an input 1 (A) on a sub-monitor (left).</p> <p>Indicates an input 2 (V) on a sub-monitor (right).</p> <p>Indicates an DC power (W) the main monitor.</p> <p>New setting</p> </div> </div> <div style="display: flex; justify-content: space-between;"> <div style="width: 48%;"> <p>• Unit display setting of input 1 (Pattern 1)</p> <p>Setting No.      New setting      Current setting</p>  <p>Unit display</p> </div> <div style="width: 48%;"> <p>• INPUT display ON/OFF setting (Pattern 1)</p> <p>Setting No.      New setting      Current setting</p>  </div> </div>	

Display combination list	Display position change is attained with display combination. And it is possible of setting of DC power (W) measurement and DC electric-energy (Wh) measurement. Pattern 1 : Standard product , Pattern 2 to 6 : At the case of display position designating, Pattern 7 to C : At the case of DC power (W) measurement designating, Pattern D to J : At the case of DC electric energy (Wh) measurement designating										
	Pattern No.	1 input specification			2 input specification			3 input specification			INPUT display
		Main monitor	Sub-monitor (left)	Sub-monitor (right)	Main monitor	Sub-monitor (left)	Sub-monitor (right)	Main monitor	Sub-monitor (left)	Sub-monitor (right)	
	Pattern 1	INPUT 1	—	—	INPUT 1	INPUT 2	—	INPUT 1	INPUT 2	INPUT 3	ON/OFF
	Pattern 2				INPUT 1	—	INPUT 2	INPUT 1	INPUT 3	INPUT 2	OFF
	Pattern 3				INPUT 2	INPUT 1	—	INPUT 2	INPUT 1	INPUT 3	OFF
	Pattern 4				INPUT 2	—	INPUT 1	INPUT 2	INPUT 3	INPUT 1	OFF
	Pattern 5				—	INPUT 1	INPUT 2	INPUT 3	INPUT 1	INPUT 2	OFF
	Pattern 6				—	INPUT 2	INPUT 1	INPUT 3	INPUT 2	INPUT 1	OFF
	Pattern 7				W	A	V	W	A	V	OFF
	Pattern 8				W	V	A	W	V	A	OFF
	Pattern 9				A	V	W *	A	V	W *	OFF
	Pattern A				A	W *	V	A	W *	V	OFF
	Pattern B				V	A	W *	V	A	W *	OFF
	Pattern C				V	W *	A	V	W *	A	OFF
	Pattern D				Wh *	A	V	Wh *	A	V	OFF
	Pattern E				Wh *	V	A	Wh *	V	A	OFF
	Pattern F				Wh *	A	W *	Wh *	A	W *	OFF
	Pattern G				Wh *	V	W *	Wh *	V	W *	OFF
	Pattern H				Wh *	W *	A	Wh *	W *	A	OFF
Pattern J				Wh *	W *	V	Wh *	W *	V	OFF	
* : Lettering											
Unit display list	With display combination, the setting range of a unit display of an input factor changes.										
	Unit display No.	INPUT 1			INPUT 2			INPUT 3			
		Pattern 1, 2	Pattern 3 to 6	Pattern 7 to J	Pattern 3, 4	Pattern 1, 2, 5, 6	Pattern 7 to J	Pattern 5, 6	Pattern 1 to 4	Pattern 7 to 8	Pattern 9 to J
	0	Not display	Not display	Not display	Not display	Not display	Not display	Not display	Not display	Not display	
	1	A	A	A	A	A	A	A	A	—	
	2	kA	kA	kA	kA	kA	kA	kA	kA	—	
	3	V	V	V	V	V	V	V	V	—	
	4	kV	kV	kV	kV	kV	kV	kV	kV	—	
	5	W	°C	—	W	°C	—	W	°C	W	
	6	kW	%	—	kW	%	—	kW	%	kW	
	7	MW	m	—	MW	m	—	MW	m	MW	
	8	°C	m <sup>3</sup>	—	°C	m <sup>3</sup>	—	°C	m <sup>3</sup>	—	
	9	%	m <sup>3</sup> /h	—	%	m <sup>3</sup> /h	—	%	m <sup>3</sup> /h	—	
	10	m	m <sup>3</sup> /min	—	m	m <sup>3</sup> /min	—	m	m <sup>3</sup> /min	—	
	11	m <sup>3</sup>	r/min	—	m <sup>3</sup>	r/min	—	m <sup>3</sup>	r/min	—	
	12	m <sup>3</sup> /h	min	—	m <sup>3</sup> /h	min	—	m <sup>3</sup> /h	min	—	
	13	m <sup>3</sup> /min	—	—	m <sup>3</sup> /min	—	—	m <sup>3</sup> /min	—	—	
	14	m/h	—	—	m/h	—	—	m/h	—	—	
15	m/min	—	—	m/min	—	—	m/min	—	—		
16	r/min	—	—	r/min	—	—	r/min	—	—		
17	min	—	—	min	—	—	min	—	—		

Please appoint the unit of lettering.

About the display at the case of the DC power (W) measurement, and analog output.

If display combination setting is set as pattern 7 to J, it measures DC power (W).

Please refer to the following list about action of a display and analog output.

The scale of DC power (W), from scaling of input 1(A) and input 2(V) it does automatic scaling.

<p>Example ①</p>	<p>Input 1 (A) : 0 to 60mV , Display : 0.0 to 100.0A                  Input 2 (V) : 0 to 200V , Display : 0.0 to 200.0V                  DC power (W) display : 0.00 to 20.00kW</p>
<p>Display, Analog output</p>	<div style="display: flex; justify-content: space-around;"> <div style="text-align: center;"> <p>DC power (W) display</p> </div> <div style="text-align: center;"> <p>DC power (W) analog output</p> </div> </div>
<p>Example ②</p>	<p>Input 1 (A) : ±60mV , Display : ±100.0A                  Input 2 (V) : 0 to 200V , Display : 0.0 to 200.0V                  DC power (W) display : ±20.00kW</p>
<p>Display, Analog output</p>	<div style="display: flex; justify-content: space-around;"> <div style="text-align: center;"> <p>DC power (W) display</p> </div> <div style="text-align: center;"> <p>DC power (W) analog output</p> </div> </div>
<p>Example ③</p>	<p>Input 1 (A) : ±60mV , Display : ±100.0A                  Input 2 (V) : ±200V , Display : ±200.0V                  DC power (W) display : ±20.00kW</p>
<p>Display, Analog output</p>	<div style="display: flex; justify-content: space-around;"> <div style="text-align: center;"> <p>DC power (W) display</p> </div> <div style="text-align: center;"> <p>DC power (W) analog output</p> </div> </div>

(2) Flicker setting (Setting No. 121H to 129)

The upper limit and low limit setting of the flicker of an input factor, and ON/OFF setting can be performed. However, setting of an upper limit value and a lower limit value turns into setting in the range of an upper limit value > lower limit value.

<p>Setting process</p>																																
<p>Setting item</p>	<table border="1"> <thead> <tr> <th>Setting No.</th> <th>Contents of a setting</th> <th>Setting value possible range</th> </tr> </thead> <tbody> <tr> <td>121H</td> <td>Upper limit flicker setting of input 1</td> <td>-20% to 120% of display span. OFF <sup>(20)</sup></td> </tr> <tr> <td>122L</td> <td>Lower limit flicker setting of input 1</td> <td>-20% to 120% of display span. OFF <sup>(20)</sup></td> </tr> <tr> <td>123</td> <td>Flicker ON/OFF setting of input 1</td> <td>ON/OFF</td> </tr> <tr> <td>124H</td> <td>Upper limit flicker setting of input 2</td> <td>-20% to 120% of display span. OFF <sup>(20)</sup></td> </tr> <tr> <td>125L</td> <td>Lower limit flicker setting of input 2</td> <td>-20% to 120% of display span. OFF <sup>(20)</sup></td> </tr> <tr> <td>126</td> <td>Flicker ON/OFF setting of input 2</td> <td>ON/OFF</td> </tr> <tr> <td>127H</td> <td>Upper limit flicker setting of input 3</td> <td>-20% to 120% of display span. OFF <sup>(20)</sup></td> </tr> <tr> <td>128L</td> <td>Lower limit flicker setting of input 3</td> <td>-20% to 120% of display span. OFF <sup>(20)</sup></td> </tr> <tr> <td>129</td> <td>Flicker ON/OFF setting of input 3</td> <td>ON/OFF</td> </tr> </tbody> </table>	Setting No.	Contents of a setting	Setting value possible range	121H	Upper limit flicker setting of input 1	-20% to 120% of display span. OFF <sup>(20)</sup>	122L	Lower limit flicker setting of input 1	-20% to 120% of display span. OFF <sup>(20)</sup>	123	Flicker ON/OFF setting of input 1	ON/OFF	124H	Upper limit flicker setting of input 2	-20% to 120% of display span. OFF <sup>(20)</sup>	125L	Lower limit flicker setting of input 2	-20% to 120% of display span. OFF <sup>(20)</sup>	126	Flicker ON/OFF setting of input 2	ON/OFF	127H	Upper limit flicker setting of input 3	-20% to 120% of display span. OFF <sup>(20)</sup>	128L	Lower limit flicker setting of input 3	-20% to 120% of display span. OFF <sup>(20)</sup>	129	Flicker ON/OFF setting of input 3	ON/OFF	
Setting No.	Contents of a setting	Setting value possible range																														
121H	Upper limit flicker setting of input 1	-20% to 120% of display span. OFF <sup>(20)</sup>																														
122L	Lower limit flicker setting of input 1	-20% to 120% of display span. OFF <sup>(20)</sup>																														
123	Flicker ON/OFF setting of input 1	ON/OFF																														
124H	Upper limit flicker setting of input 2	-20% to 120% of display span. OFF <sup>(20)</sup>																														
125L	Lower limit flicker setting of input 2	-20% to 120% of display span. OFF <sup>(20)</sup>																														
126	Flicker ON/OFF setting of input 2	ON/OFF																														
127H	Upper limit flicker setting of input 3	-20% to 120% of display span. OFF <sup>(20)</sup>																														
128L	Lower limit flicker setting of input 3	-20% to 120% of display span. OFF <sup>(20)</sup>																														
129	Flicker ON/OFF setting of input 3	ON/OFF																														
<p>Setting method</p>	<p>Setting display</p> <p>Setting value change</p> <p>Update of setting value</p> <p>Return to default setting</p>	<p>Setting mode 1 is selected by pressing <b>SET</b> switch for longer than 3 seconds. For shifting to the item of flicker setting, press <b>+</b> and <b>RESET/SHIFT</b> or <b>-</b> and <b>RESET/SHIFT</b> together. Whenever it presses <b>RESET/SHIFT</b> switch, setting item changes.</p> <p>If a <b>+</b> switch or <b>-</b> switch is pressed, the set value will change. The set point can change in high-speed operation gradually by continuing pressing <b>+</b> or <b>-</b> switch. A detecting function will be excepted if it is made setting which exceeds 120% by upper limit flicker setting. (OFF, ▲ disappears.) A detecting function will be excepted if it is made setting which exceeds -20% by lower limit flicker setting. (OFF, ▲ disappears.)</p> <p>Note<sup>(20)</sup> Set value possible range when doing COS<math>\phi</math> display setting, 0% to 100% and OFF of display span.</p> <p>If a <b>SET</b> switch is pressed, the set point will update.</p> <p>If <b>+</b> and <b>-</b> switches are pressed together for longer than 3 seconds during setting, the present set values only are reset to the default setting values. However, both an upper limit flicker value and a lower limit flicker value return to a default setting.</p>																														
<p>Reset method</p>	<p>Press the <b>DISPLAY</b> switch or returns to a measurement display mode by no operating it for 10 minutes.</p>																															



Display	<ul style="list-style-type: none"> <li>•Upper limit flicker value setting of input 1.</li> </ul>	<ul style="list-style-type: none"> <li>•Lower limit flicker value setting of input 1.</li> </ul>	<ul style="list-style-type: none"> <li>•Flicker ON/OFF setting of input 1.</li> </ul>
	Setting No.    Current setting 	Setting No.    Current setting 	Setting No.    Current setting 
	New setting    Setting index	Setting index    New setting	New setting

(3) **DISPLAY** switch function change setting (Setting No. No. 131)

The function of **DISPLAY** switch and **+** switch can be replaced.

Setting process	Setting No. 131 		
Setting item	Setting No.	Contents of setting	Setting value possible range
	131	Function exchange of <b>DISPLAY</b> switch and <b>+</b> switch	0, 1
Setting method	Setting display	Setting mode 1 is selected by pressing <b>SET</b> switch for longer than 3 seconds. For shifting to the item of DISPLAY switch-function exchange setting, press <b>+</b> and <b>RESET/SHIFT</b> or <b>-</b> and <b>RESET/SHIFT</b> together.	
	Setting value change	If a <b>+</b> switch or <b>-</b> switch is pressed, the set value will change.	
	Update of setting value	If a <b>SET</b> switch is pressed, the set point will update.	
	Return to default setting	If <b>+</b> and <b>-</b> switches are pressed together for longer than 3 seconds during setting, the present set values only are reset to the default setting values.	
Reset method	Press the <b>DISPLAY</b> switch or returns to a measurement display mode by no operating it for 10 minutes.		
Display	<ul style="list-style-type: none"> <li>• DISPLAY switch-function exchange setting</li> </ul> Setting No.    Current setting 		

(4) Multiplying factor setting, output pulse unit (kWh/pulse) setting. (Setting No. 141 to 142P)

Set the multiplying factor and output pulse unit.

Setting of multiplying factor is possible at display pattern D to J.

Setting of an output pulse unit is possible for the case with a pulse output (option).

Setting process

□ Default setting

Please designate multiplying factor.  
Please use it with the same value as the multiplying factor indicated on the front filter. (It is set as the same value at the case of shipping.)  
The output pulse unit (kWh / pulse) can be set in 4 steps depending on the value of the magnification.

(Example) The output pulse unit at the time of designating multiplying factor 1.  
10, 1, 0.1, 0.01 is possible.

Multiplying factor	Output pulse unit (kWh/pulse) setting range			
	1	0.1	0.01	0.001
×0.1	1	0.1	0.01	0.001
×1	10	1	0.1	0.01
×10	100	10	1	0.1
×100	1000	100	10	1
×1000	* 10000	1000	100	10

\* A display of the output pulse unit 10000 will be 9999. (For four digits of displays)

Setting item	Setting No.	Contents of setting	Setting value possible range
	141	Multiplying factor	0.1, 1, 10, 100, 1000
	142P	Output pulse unit (kWh/pulse)	Please refer to upper list.
Setting method	Setting display	Setting mode 1 is selected by pressing <b>SET</b> switch for longer than 3 seconds. For shifting to the item of multiplying factor setting and output pulse unit setting, press <b>+</b> and <b>RESET/SHIFT</b> or <b>-</b> and <b>RESET/SHIFT</b> together. Whenever it presses <b>RESET/SHIFT</b> switch, setting item changes.	
	Setting value change	If a <b>+</b> switch or <b>-</b> switch is pressed, the set value will change.	
	Update of setting value	If a <b>SET</b> switch is pressed, the set point will update.	
	Return to default setting	If <b>+</b> and <b>-</b> switches are pressed together for longer than 3 seconds during setting, the present set values only are reset to the default setting values.	
Reset method	Press the <b>DISPLAY</b> switch or returns to a measurement display mode by no operating it for 10 minutes.		

Voltage (V) × Current (A)	Multiplying factor setting range
Less than 100kW	×0.1 , ×1 , ×10 , ×100 , ×1000
More than 100kW, Less than 1000kW	×1 , ×10 , ×100 , ×1000
More than 1000kW, Less than 10000kW	×10 , ×100 , ×1000
More than 10000kW, Less than 100000kW	×100 , ×1000

(5) Backlight setting (Setting No. 151 to 152) 【White backlight only】

Set the action and brightness of backlight. The backlight setting is only white backlight products.

**Setting process**

- ◆ 151 Backlight action  
The operation of the backlight can be selected from ON (always on), AUTO (auto off), and OFF (always off).  
If 5 minutes elapses without operating a switch in case it is set as "AUTO (auto off)", backlight is automatically off.  
After that, backlight will be turned on if either of switches is operated.  
Selection by **[+]** and **[-]**, set value is updated by **[SET]**.
- ◆ 152 Backlight brightness  
The backlight brightness can be selected from 5 levels from 1 to 5.  
Backlight becomes the darkest if it is set as "1". Backlight becomes the brightest if it is set as "5".  
Selection by **[+]** and **[-]**, set value is updated by **[SET]**.

Setting value	Brightness
5	Bright ↑ ↓ Dark
4	
3	
2	
1	

Setting item	Setting No.	Contents of setting	Setting value possible range
	151	Backlight action	AUTO (Auto OFF), OFF (always-off), ON (always-on)
	152	Backlight brightness	1, 2, 3, 4, 5

Setting method	Setting display	Setting mode 1 is selected by pressing <b>[SET]</b> switch for longer than 3 seconds. For shifting to the item of backlight setting, press <b>[+]</b> and <b>[RESET/SHIFT]</b> or <b>[-]</b> and <b>[RESET/SHIFT]</b> together. Whenever it presses <b>[RESET/SHIFT]</b> switch, setting item changes.
	Setting value change	If a <b>[+]</b> switch or <b>[-]</b> switch is pressed, the set value will change.
	Update of setting value	If a <b>[SET]</b> switch is pressed, the set point will update.
	Return to default setting	If <b>[+]</b> and <b>[-]</b> switches are pressed together for longer than 3 seconds during setting, the present set values only are reset to the default setting values.

Reset method	Press the <b>[DISPLAY]</b> switch or returns to a measurement display mode by no operating it for 10 minutes.
--------------	---

**Display**

• Backlight action setting

## 6.5.2 Setting mode 2

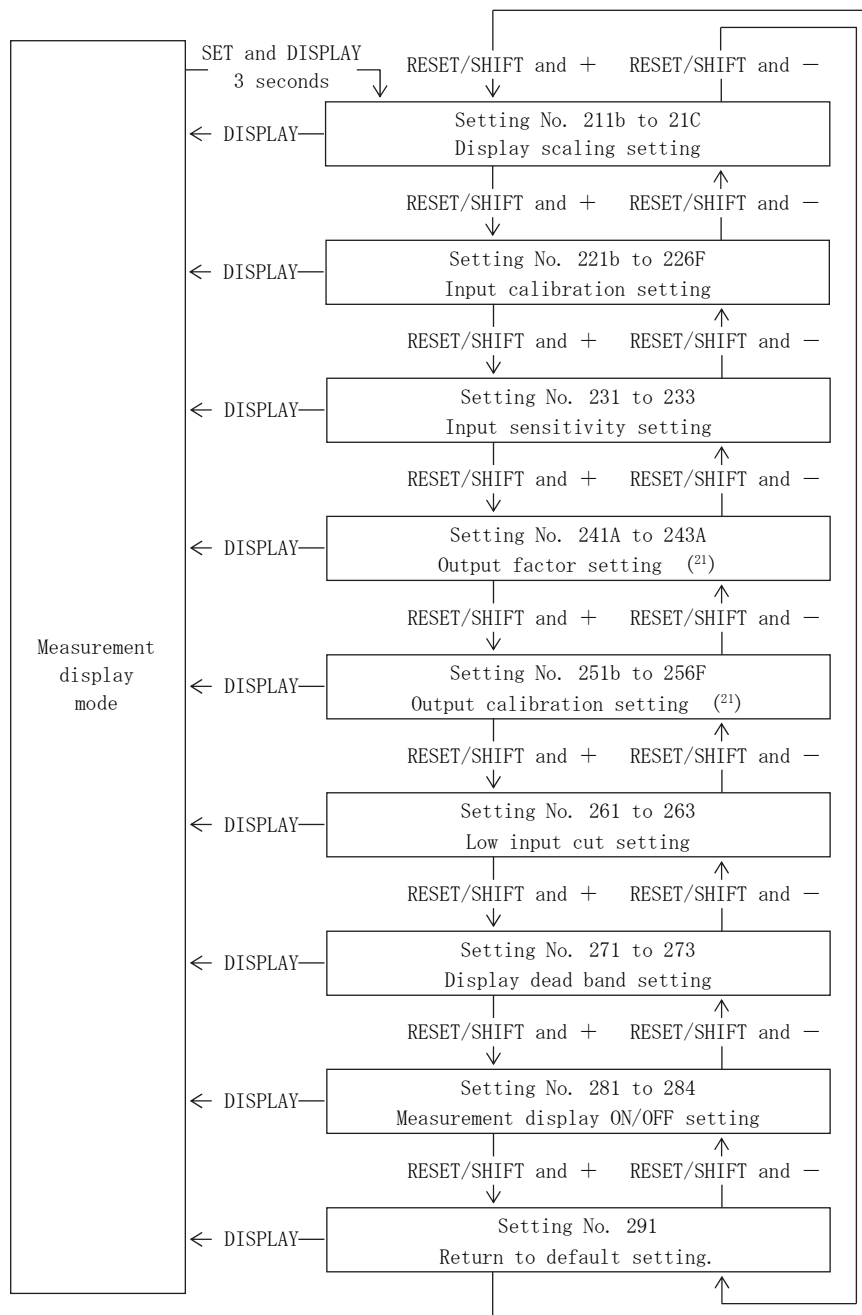

If **SET** switch and **DISPLAY** switch are pressed together for longer than 3 seconds, it becomes the setting mode 2 from measurement display mode.

It moves a setting item with **RESET/SHIFT** and **+** switch (or **RESET/SHIFT** and **-** switch).

If a **DISPLAY** switch is pressed, it will return to a display mode.

If **+** and **-** switches are pressed together for longer than 3 seconds during setting, the present set values only are reset to the default settings.

<Caution> There is a display item excepted by the number of input circuits or measurement display ON/OFF setting.

- In case of input 1 circuit specification, there is no display item of input 2 and input 3.
- In case of input 2 circuit specification, there is no display item of input 3.
- In the case where a measurement display is OFF altogether, the next setting is possible. Setting mode 2, "Returns to a default setting", "Measurement display ON/OFF setting".

Note<sup>(21)</sup> In case there is no analog output, there is no output setting.

(1) Display scaling setting (Setting No. 211b to 21C)

Scaling setting of the indicated value of an input factor can be performed.

However, setting of an bias value and max. value turns into setting in the range of an bias value < max. value.

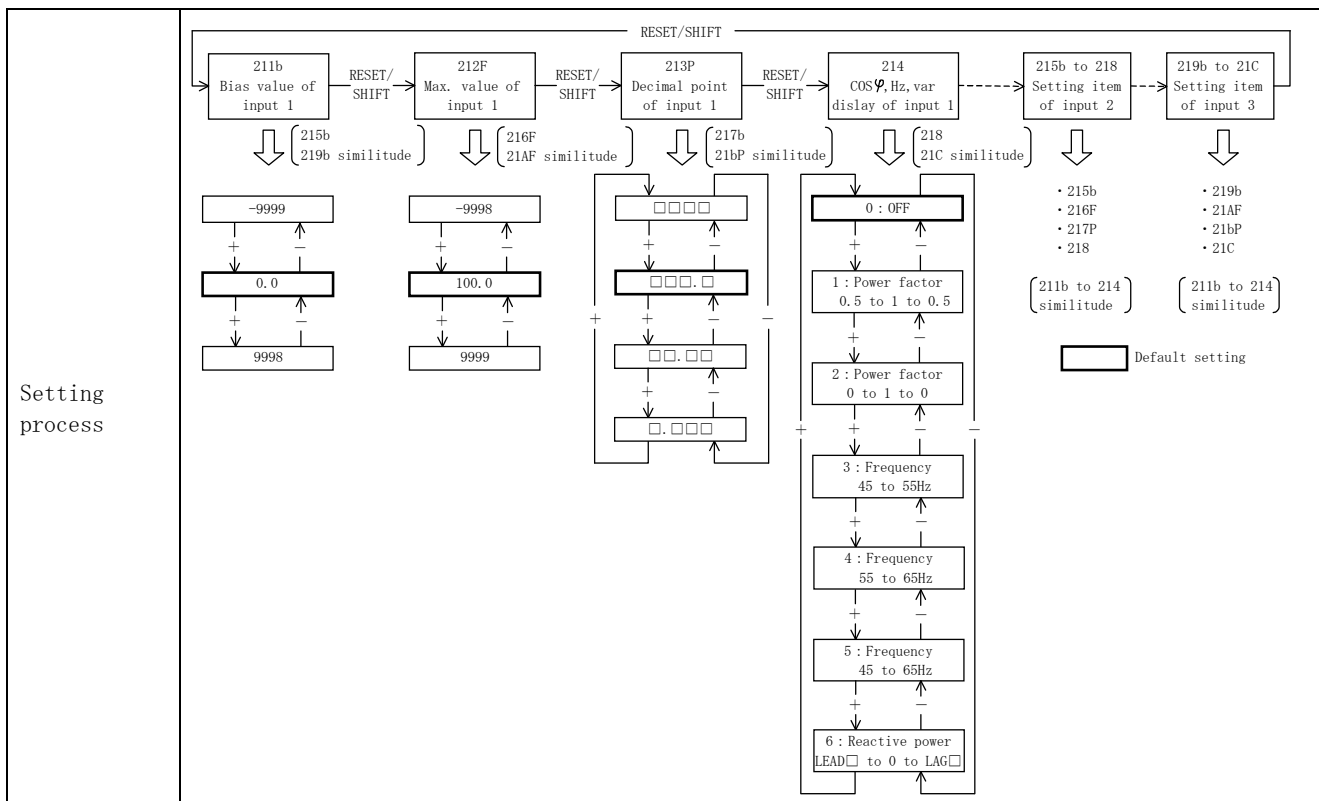

Setting No.	Contents of setting	Setting value possible range
211b	Display bias value setting of input 1	-9999 to 9998 (var : LEAD 9999 to 1)
212F	Display max. value setting of input 1	-9998 to 9999 (var : LAG 1 to 9999)
213P	Display decimal point setting of input 1	No decimal point to 3 digits decimal point
214	COSφ, Hz, var display setting of input 1	COSφ : 0.5 to 1 to 0.5 , 0 to 1 to 0
		Hz : 45 to 55Hz , 55 to 65Hz , 45 to 65Hz
		Var : LEAD□ to 0 to LAG□ (Set the □ in 211b to 213P)
215b	Display bias value setting of input 2	-9999 to 9998 (var : LEAD 9999 to 1)
216F	Display max. value setting of input 2	-9998 to 9999 (var : LAG 1 to 9999)
217P	Display decimal point setting of input 2	No decimal point to 3 digits decimal point
218	COSφ, Hz, var display setting of input 2	COSφ : 0.5 to 1 to 0.5 , 0 to 1 to 0
		Hz : 45 to 55Hz , 55 to 65Hz , 45 to 65Hz
		Var : LEAD□ to 0 to LAG□ (Set the □ in 215b to 217P)
219b	Display bias value setting of input 3	-9999 to 9998 (var : LEAD 9999 to 1)
21AF	Display max. value setting of input 3	-9998 to 9999 (var : LAG 1 to 9999)
21bP	Display decimal point setting of input 3	No decimal point to 3 digits decimal point
21C	COSφ, Hz, var display setting of input 3	COSφ : 0.5 to 1 to 0.5 , 0 to 1 to 0
		Hz : 45 to 55Hz , 55 to 65Hz , 45 to 65Hz
		Var : LEAD□ to 0 to LAG□ (Set the □ in 219b to 21bP)
Setting method	Setting display	<p>If [SET] switch and [DISPLAY] switch are pressed together for longer than 3 seconds, it becomes the setting mode 2 from measurement display mode.</p> <p>For shifting to the item of display scaling setting, press [+ ] and [RESET/SHIFT] or [- ] and [RESET/SHIFT] together.</p> <p>Whenever it presses [RESET/SHIFT] switch, setting item changes.</p> <p>If COSφ or Hz display setting is being done by display scaling setting, the display bias value of the input factor, the max. value, and decimal point setting are excepted.</p>

Setting method	Setting value change	<p>If a <math>\oplus</math> switch or <math>\ominus</math> switch is pressed, the set value will change. Set value does high-speed action gradually by continuing pressing a <math>\oplus</math> or <math>\ominus</math> switch.</p> <p>When DC power measurement (pattern 7 to J) is set, the power scale (219b to 21Bp) is automatically scaled from the scale of input 1 (current) and input 2 (voltage). The scaling can be changed manually. However, if the scaling is changed, the displayed value will be misaligned, so only change the number of digits and the decimal point of the automatically scaled value.</p> <p>If a 3 digits display and 4 digits display are switched at the case of Hz display setting, if <math>\oplus</math> switch is pressed with a <math>\text{SET}</math> switch pressed, it will change. In 4 digits display, indicates on the 4th digit of digital display as "4".</p>
	Update of setting value	<p>If a <math>\text{SET}</math> switch is pressed, the set point will update.</p> <p>The upper limit (lower limit) flicker value of the updated input factor, return to default setting. (Flicker ON/OFF setting has no change.)</p>
	Return to default setting	<p>If <math>\oplus</math> and <math>\ominus</math> switches are pressed together for longer than 3 seconds during setting, only as for the display scaling value of an input factor, and the upper limit and the lower limit flicker value which have been set up now, both return to a default setting.</p>
Reset method	<p>Press the <math>\text{DISPLAY}</math> switch or returns to a measurement display mode by no operating it for 10 minutes.</p>	
Display	<p>• Bias setting of input 1</p>	<p>• Max. setting of input 1</p>
	<p>• Decimal point setting of input 1</p>	
	<p>• COS<math>\phi</math> setting of input 1 In case of COS<math>\phi</math>: 0.5 to 1 to 0.5</p>	<p>• Hz setting of input 1 In case of frequency 45 to 55Hz (3 digits display)</p>
	<p>• var setting of input 1</p>	<p>In case of frequency 45 to 55Hz (4 digits display)</p>

(2) Input calibration setting (Setting No. 221b to 226F)

Indicated value adjustments (zero adjustment etc.) of an input factor can be performed.

<p>Setting process</p>																								
<p>Setting item</p>	<table border="1"> <thead> <tr> <th>Setting No.</th> <th>Contents of setting</th> <th>Setting value possible range</th> </tr> </thead> <tbody> <tr> <td>221b</td> <td>Calibration (bias) setting of input 1</td> <td>-9.99% to 9.99% of input span</td> </tr> <tr> <td>222F</td> <td>Calibration (span) setting of input 1</td> <td>-9.99% to 9.99% of input span</td> </tr> <tr> <td>223b</td> <td>Calibration (bias) setting of input 2</td> <td>-9.99% to 9.99% of input span</td> </tr> <tr> <td>224F</td> <td>Calibration (span) setting of input 2</td> <td>-9.99% to 9.99% of input span</td> </tr> <tr> <td>225b</td> <td>Calibration (bias) setting of input 3</td> <td>-9.99% to 9.99% of input span</td> </tr> <tr> <td>226F</td> <td>Calibration (span) setting of input 3</td> <td>-9.99% to 9.99% of input span</td> </tr> </tbody> </table>	Setting No.	Contents of setting	Setting value possible range	221b	Calibration (bias) setting of input 1	-9.99% to 9.99% of input span	222F	Calibration (span) setting of input 1	-9.99% to 9.99% of input span	223b	Calibration (bias) setting of input 2	-9.99% to 9.99% of input span	224F	Calibration (span) setting of input 2	-9.99% to 9.99% of input span	225b	Calibration (bias) setting of input 3	-9.99% to 9.99% of input span	226F	Calibration (span) setting of input 3	-9.99% to 9.99% of input span		
Setting No.	Contents of setting	Setting value possible range																						
221b	Calibration (bias) setting of input 1	-9.99% to 9.99% of input span																						
222F	Calibration (span) setting of input 1	-9.99% to 9.99% of input span																						
223b	Calibration (bias) setting of input 2	-9.99% to 9.99% of input span																						
224F	Calibration (span) setting of input 2	-9.99% to 9.99% of input span																						
225b	Calibration (bias) setting of input 3	-9.99% to 9.99% of input span																						
226F	Calibration (span) setting of input 3	-9.99% to 9.99% of input span																						
<p>Setting method</p>	<p>Setting display</p>	<p>If <b>[SET]</b> switch and <b>[DISPLAY]</b> switch are pressed together for longer than 3 seconds, it becomes the setting mode 2 from measurement display mode. For shifting to the item of input calibration setting, press <b>[+]</b> and <b>[RESET/SHIFT]</b> or <b>[-]</b> and <b>[RESET/SHIFT]</b> together. Whenever it presses <b>[RESET/SHIFT]</b> switch, setting item changes.</p> <p>Setting value change</p> <p>If a <b>[+]</b> switch or <b>[-]</b> switch is pressed, the set value will change. The set point can change in high-speed operation gradually by continuing pressing <b>[+]</b> or <b>[-]</b> switch.</p> <p>Update of setting value</p> <p>If a <b>[SET]</b> switch is pressed, the set point will update.</p> <p>Return to default setting</p> <p>If <b>[+]</b> and <b>[-]</b> switches are pressed together for longer than 3 seconds during setting, the present set values only are reset to the default setting values.</p>																						
<p>Reset method</p>	<p>Press the <b>[DISPLAY]</b> switch or returns to a measurement display mode by no operating it for 10 minutes.</p>																							
<p>Display</p>	<table border="0"> <tr> <td style="vertical-align: top;"> <p>•Bias setting of input 1</p> <p>Setting No.    Setting value</p> </td> <td style="vertical-align: top;"> <p>•Span setting of input 1</p> <p>Setting No.    Setting value</p> </td> </tr> <tr> <td style="text-align: center;"> <p>Current measurement value</p> </td> <td style="text-align: center;"> <p>Current measurement value</p> </td> </tr> </table>			<p>•Bias setting of input 1</p> <p>Setting No.    Setting value</p>	<p>•Span setting of input 1</p> <p>Setting No.    Setting value</p>	<p>Current measurement value</p>	<p>Current measurement value</p>																	
<p>•Bias setting of input 1</p> <p>Setting No.    Setting value</p>	<p>•Span setting of input 1</p> <p>Setting No.    Setting value</p>																							
<p>Current measurement value</p>	<p>Current measurement value</p>																							

(3) Input sensitivity (bar graph full-scale) setting (Setting No. 231 to 233)

Sensitivity change of the bar graph display of an input factor can be performed.

<p>Setting process</p>															
<p>Setting item</p>	<table border="1"> <thead> <tr> <th>Setting No.</th> <th>Contents of setting</th> <th>Setting value possible range <sup>(22)</sup></th> </tr> </thead> <tbody> <tr> <td>231</td> <td>Input sensitivity (bar graph full-scale) setting of input 1</td> <td>1% to 100% of full scale</td> </tr> <tr> <td>232</td> <td>Input sensitivity (bar graph full-scale) setting of input 2</td> <td>1% to 100% of full scale</td> </tr> <tr> <td>233</td> <td>Input sensitivity (bar graph full-scale) setting of input 3</td> <td>1% to 100% of full scale</td> </tr> </tbody> </table>	Setting No.	Contents of setting	Setting value possible range <sup>(22)</sup>	231	Input sensitivity (bar graph full-scale) setting of input 1	1% to 100% of full scale	232	Input sensitivity (bar graph full-scale) setting of input 2	1% to 100% of full scale	233	Input sensitivity (bar graph full-scale) setting of input 3	1% to 100% of full scale		
Setting No.	Contents of setting	Setting value possible range <sup>(22)</sup>													
231	Input sensitivity (bar graph full-scale) setting of input 1	1% to 100% of full scale													
232	Input sensitivity (bar graph full-scale) setting of input 2	1% to 100% of full scale													
233	Input sensitivity (bar graph full-scale) setting of input 3	1% to 100% of full scale													
<p>Setting method</p>	<p>Setting display</p>	<p>If <b>SET</b> switch and <b>DISPLAY</b> switch are pressed together for longer than 3 seconds, it becomes the setting mode 2 from measurement display mode. For shifting to the item of input sensitivity setting, press <b>+</b> and <b>RESET/SHIFT</b> or <b>-</b> and <b>RESET/SHIFT</b> together. Whenever it presses <b>RESET/SHIFT</b> switch, setting item changes. If COS<math>\phi</math> or Hz display setting is being done by display scaling setting, only the item of the input factor is excepted.</p> <p>Setting value change If a <b>+</b> switch or <b>-</b> switch is pressed, the set value will change.</p> <p>Update of setting value If a <b>SET</b> switch is pressed, the set point will update.</p> <p>Return to default setting If <b>+</b> and <b>-</b> switches are pressed together for longer than 3 seconds during setting, the present set values only are reset to the default setting values.</p>													
<p>Reset method</p>	<p>Press the <b>DISPLAY</b> switch or returns to a measurement display mode by no operating it for 10 seconds.</p>														
<p>Display</p>	<p>•Input sensitivity setting of input 1</p> <p>Current setting value</p> <p>New setting</p>														

Note<sup>(22)</sup> As for less than 39% of input sensitivity setting, the accuracy of a bar graph display differs.



(4) Output factor setting (Setting No. 241A to 243A)

The factor of the analog output to an input factor can be set up.  
 Analog output will not be outputted if it sets up without a factor.  
 (Example : It is set to 0mA at the case of 4 to 20mA.)

When there is no analog output, this setting item does not exist. And, setting of the input factor set as OFF by measurement display ON/OFF is impossible.

<p>Setting process</p>															
<p>Setting item</p>	<table border="1"> <thead> <tr> <th>Setting No.</th> <th>Contents of setting</th> <th>Setting value possible range</th> </tr> </thead> <tbody> <tr> <td>241A</td> <td>Input factor setting of output 1</td> <td>Input 1 to 3 (DC power), No factor</td> </tr> <tr> <td>242A</td> <td>Input factor setting of output 2</td> <td>Input 1 to 3 (DC power), No factor</td> </tr> <tr> <td>243A</td> <td>Input factor setting of output 3</td> <td>Input 1 to 3 (DC power), No factor</td> </tr> </tbody> </table>	Setting No.	Contents of setting	Setting value possible range	241A	Input factor setting of output 1	Input 1 to 3 (DC power), No factor	242A	Input factor setting of output 2	Input 1 to 3 (DC power), No factor	243A	Input factor setting of output 3	Input 1 to 3 (DC power), No factor		
Setting No.	Contents of setting	Setting value possible range													
241A	Input factor setting of output 1	Input 1 to 3 (DC power), No factor													
242A	Input factor setting of output 2	Input 1 to 3 (DC power), No factor													
243A	Input factor setting of output 3	Input 1 to 3 (DC power), No factor													
<p>Setting method</p>	<p>Setting display</p>	<p>If <b>SET</b> switch and <b>DISPLAY</b> switch are pressed together for longer than 3 seconds, it becomes the setting mode 2 from measurement display mode.                  For shifting to the item of output factor setting, press <b>+</b> and <b>RESET/SHIFT</b> or <b>-</b> and <b>RESET/SHIFT</b> together.                  Whenever it presses <b>RESET/SHIFT</b> switch, setting item changes.</p>													
	<p>Setting value change</p>	<p>If a <b>+</b> switch or <b>-</b> switch is pressed, the set value will change.                  Setting of the input factor set as OFF by measurement display ON/OFF is impossible.</p>													
	<p>Update of setting value</p>	<p>If a <b>SET</b> switch is pressed, the set point will update.                  Analog output will not be outputted if it sets up without a factor.                  (Example : It is set to 0mA at the case of 4 to 20mA.)</p>													
	<p>Return to default setting</p>	<p>If <b>+</b> and <b>-</b> switches are pressed together for longer than 3 seconds during setting, the present set values only are reset to the default setting values.                  However, it is set up without a factor when the input factor of a default setting is OFF.                  And, the input factors of a default setting are different with numbers of circuits of an input and an output.</p>													
<p>Reset method</p>	<p>Press the <b>DISPLAY</b> switch or returns to a measurement display mode by no operating it for 10 seconds.</p>														
<p>Display</p>	<p>• Factor setting of an output 1</p>														

(5) Output calibration setting (Setting No. 251b to 256F)

Adjustment of the output value of analog output can be performed.  
 In case there is no analog output, this setting item does not exist.

<p>Setting process</p>																								
<p>Setting item</p>	<table border="1"> <thead> <tr> <th>Setting No.</th> <th>Contents of setting</th> <th>Setting value possible range</th> </tr> </thead> <tbody> <tr> <td>251b</td> <td>Calibration (bias) setting of output 1</td> <td>-9.99% to 9.99% for output span</td> </tr> <tr> <td>252F</td> <td>Calibration (span) setting of output 1</td> <td>-9.99% to 99.00% for output span <sup>(23)</sup></td> </tr> <tr> <td>253b</td> <td>Calibration (bias) setting of output 2</td> <td>-9.99% to 9.99% for output span</td> </tr> <tr> <td>254F</td> <td>Calibration (span) setting of output 2</td> <td>-9.99% to 99.00% for output span <sup>(23)</sup></td> </tr> <tr> <td>255b</td> <td>Calibration (bias) setting of output 3</td> <td>-9.99% to 9.99% for output span</td> </tr> <tr> <td>256F</td> <td>Calibration (span) setting of output 3</td> <td>-9.99% to 99.00% for output span <sup>(23)</sup></td> </tr> </tbody> </table>	Setting No.	Contents of setting	Setting value possible range	251b	Calibration (bias) setting of output 1	-9.99% to 9.99% for output span	252F	Calibration (span) setting of output 1	-9.99% to 99.00% for output span <sup>(23)</sup>	253b	Calibration (bias) setting of output 2	-9.99% to 9.99% for output span	254F	Calibration (span) setting of output 2	-9.99% to 99.00% for output span <sup>(23)</sup>	255b	Calibration (bias) setting of output 3	-9.99% to 9.99% for output span	256F	Calibration (span) setting of output 3	-9.99% to 99.00% for output span <sup>(23)</sup>		
Setting No.	Contents of setting	Setting value possible range																						
251b	Calibration (bias) setting of output 1	-9.99% to 9.99% for output span																						
252F	Calibration (span) setting of output 1	-9.99% to 99.00% for output span <sup>(23)</sup>																						
253b	Calibration (bias) setting of output 2	-9.99% to 9.99% for output span																						
254F	Calibration (span) setting of output 2	-9.99% to 99.00% for output span <sup>(23)</sup>																						
255b	Calibration (bias) setting of output 3	-9.99% to 9.99% for output span																						
256F	Calibration (span) setting of output 3	-9.99% to 99.00% for output span <sup>(23)</sup>																						
<p>Setting method</p>	<p>Setting display</p>	<p>If <b>SET</b> switch and <b>DISPLAY</b> switch are pressed together for longer than 3 seconds, it becomes the setting mode 2 from measurement display mode. For shifting to the item of output calibration setting, press <b>+</b> and <b>RESET/SHIFT</b> or <b>-</b> and <b>RESET/SHIFT</b> together. Whenever it presses <b>RESET/SHIFT</b> switch, setting item changes. By output factor setting, the setting item of the output set as "No factor" is excepted.</p>																						
<p>Setting value change</p>	<p>If a <b>+</b> switch or <b>-</b> switch is pressed, the set value will change. The set point can change in high-speed operation gradually by continuing pressing <b>+</b> or <b>-</b> switch.</p>																							
<p>Update of setting value</p>	<p>If a <b>SET</b> switch is pressed, the set point will update.</p>																							
<p>Return to default setting</p>	<p>If <b>+</b> and <b>-</b> switches are pressed together for longer than 3 seconds during setting, the present set values only are reset to the default setting values.</p>																							
<p>Reset method</p>	<p>Press the <b>DISPLAY</b> switch or returns to a measurement display mode by no operating it for 10 seconds.</p>																							
<p>Display</p>	<table border="0"> <tr> <td style="vertical-align: top;"> <p>•Bias setting of output 1. Setting No.    Setting value</p> <p>Current measurement value</p> </td> <td style="vertical-align: top;"> <p>•Span setting of output 1. Setting No.    Setting value</p> <p>Current measurement value</p> </td> </tr> </table>			<p>•Bias setting of output 1. Setting No.    Setting value</p> <p>Current measurement value</p>	<p>•Span setting of output 1. Setting No.    Setting value</p> <p>Current measurement value</p>																			
<p>•Bias setting of output 1. Setting No.    Setting value</p> <p>Current measurement value</p>	<p>•Span setting of output 1. Setting No.    Setting value</p> <p>Current measurement value</p>																							

Note<sup>(23)</sup> As for more than 60.01% of output calibration span setting, the accuracy of a analog output differs.

(6) Low input cut setting (Setting No. 261 to 263)

Indicated value is fixed to 0 at the case of the minute input equivalent to less than 0.5% of an input span. However, effective only at the case of display scaling 0 to N, and -N to 0 to N (example : -100 to 0 to 100). Don't function at the case of -N' to 0 to N (example : -10 to 0 to 100) and -N to 0.

<p>Setting process</p>			
<p>Setting item</p>	<p>Setting No.</p>	<p>Contents of setting</p>	<p>Setting value possible range</p>
	<p>261</p>	<p>Low input cut setting of input 1</p>	<p>ON/OFF</p>
	<p>262</p>	<p>Low input cut setting of input 2</p>	<p>ON/OFF</p>
	<p>263</p>	<p>Low input cut setting of input 3</p>	<p>ON/OFF</p>
<p>Setting method</p>	<p>Setting display</p>	<p>If <b>SET</b> switch and <b>DISPLAY</b> switch are pressed together for longer than 3 seconds, it becomes the setting mode 2 from measurement display mode. For shifting to the item of low input cut setting, press <b>+</b> and <b>RESET/SHIFT</b> or <b>-</b> and <b>RESET/SHIFT</b> together. Whenever it presses <b>RESET/SHIFT</b> switch, setting item changes.</p>	
	<p>Setting value change</p>	<p>If a <b>+</b> switch or <b>-</b> switch is pressed, the set value will change.</p>	
	<p>Update of setting value</p>	<p>If a <b>SET</b> switch is pressed, the set point will update.</p>	
	<p>Return to default setting</p>	<p>If <b>+</b> and <b>-</b> switches are pressed together for longer than 3 seconds during setting, the present set values only are reset to the default setting values.</p>	
<p>Reset method</p>	<p>Press the <b>DISPLAY</b> switch or returns to a measurement display mode by no operating it for 10 seconds.</p>		
<p>Display</p>	<p>• Low input cut setting of input 1</p>		

(7) Display dead band setting (Setting No. 271 to 273)

Set to suppress the variation in the indicated value by input variation.

<p>Setting process</p>															
<p>Setting item</p>	<table border="1"> <thead> <tr> <th>Setting No.</th> <th>Contents of setting</th> <th>Setting value possible range</th> </tr> </thead> <tbody> <tr> <td>271</td> <td>Display dead band setting of input 1</td> <td>0.0% to 2.0%</td> </tr> <tr> <td>272</td> <td>Display dead band setting of input 2</td> <td>0.0% to 2.0%</td> </tr> <tr> <td>273</td> <td>Display dead band setting of input 3</td> <td>0.0% to 2.0%</td> </tr> </tbody> </table>	Setting No.	Contents of setting	Setting value possible range	271	Display dead band setting of input 1	0.0% to 2.0%	272	Display dead band setting of input 2	0.0% to 2.0%	273	Display dead band setting of input 3	0.0% to 2.0%		
Setting No.	Contents of setting	Setting value possible range													
271	Display dead band setting of input 1	0.0% to 2.0%													
272	Display dead band setting of input 2	0.0% to 2.0%													
273	Display dead band setting of input 3	0.0% to 2.0%													
<p>Setting method</p>	<p>Setting display</p>	<p>If <b>SET</b> switch and <b>DISPLAY</b> switch are pressed together for longer than 3 seconds, it becomes the setting mode 2 from measurement display mode. For shifting to the item of display dead band setting, press <b>+</b> and <b>RESET/SHIFT</b> or <b>-</b> and <b>RESET/SHIFT</b> together. Whenever it presses <b>RESET/SHIFT</b> switch, setting item changes.</p>													
<p>Setting value change</p>		<p>If a <b>+</b> switch or <b>-</b> switch is pressed, the set value will change.</p>													
<p>Update of setting value</p>		<p>If a <b>SET</b> switch is pressed, the set point will update.</p>													
<p>Return to default setting</p>		<p>If <b>+</b> and <b>-</b> switches are pressed together for longer than 3 seconds during setting, the present set values only are reset to the default setting values.</p>													
<p>Reset method</p>	<p>Press the <b>DISPLAY</b> switch or returns to a measurement display mode by no operating it for 10 seconds.</p>														
<p>Display</p>	<p>• Display dead band setting of input 1</p>														

(8) Measurement display ON/OFF setting (Setting No. 281 to 284)

Set the measurement display ON/OFF of an input factor.

Related output elements cannot be set for input elements that are OFF by this setting.

And in case setting the input factor of OFF, the output is OFF.

If measurement display setting is ON from OFF, because an output is still OFF, please redo setting of the output factor setting.

<p>Setting process</p>																		
<p>Setting item</p>	<table border="1"> <thead> <tr> <th>Setting No.</th> <th>Contents of setting</th> <th>Setting value possible range</th> </tr> </thead> <tbody> <tr> <td>281</td> <td>Measurement display ON/OFF setting of input 1</td> <td>ON/OFF</td> </tr> <tr> <td>282</td> <td>Measurement display ON/OFF setting of input 2</td> <td>ON/OFF</td> </tr> <tr> <td>283</td> <td>Measurement display ON/OFF setting of input 3</td> <td>ON/OFF</td> </tr> <tr> <td>284 <sup>(24)</sup></td> <td>Measurement display ON/OFF setting of DC electric energy (Wh)</td> <td>ON/OFF</td> </tr> </tbody> </table>	Setting No.	Contents of setting	Setting value possible range	281	Measurement display ON/OFF setting of input 1	ON/OFF	282	Measurement display ON/OFF setting of input 2	ON/OFF	283	Measurement display ON/OFF setting of input 3	ON/OFF	284 <sup>(24)</sup>	Measurement display ON/OFF setting of DC electric energy (Wh)	ON/OFF		
Setting No.	Contents of setting	Setting value possible range																
281	Measurement display ON/OFF setting of input 1	ON/OFF																
282	Measurement display ON/OFF setting of input 2	ON/OFF																
283	Measurement display ON/OFF setting of input 3	ON/OFF																
284 <sup>(24)</sup>	Measurement display ON/OFF setting of DC electric energy (Wh)	ON/OFF																
<p>Setting method</p>	<p>Setting display</p>	<p>If <b>[SET]</b> switch and <b>[DISPLAY]</b> switch are pressed together for longer than 3 seconds, it becomes the setting mode 2 from measurement display mode. For shifting to the item of measurement display ON/OFF setting, press <b>[+]</b> and <b>[RESET/SHIFT]</b> or <b>[-]</b> and <b>[RESET/SHIFT]</b> together. Whenever it presses <b>[RESET/SHIFT]</b> switch, setting item changes.</p>																
<p>Setting value change</p>	<p>If a <b>[+]</b> switch or <b>[-]</b> switch is pressed, the set value will change.</p>																	
<p>Update of setting value</p>	<p>If a <b>[SET]</b> switch is pressed, the set point will update.</p>																	
<p>Return to default setting</p>	<p>If <b>[+]</b> and <b>[-]</b> switches are pressed together for longer than 3 seconds during setting, the present set values only are reset to the default setting values.</p>																	
<p>Reset method</p>	<p>Press the <b>[DISPLAY]</b> switch or returns to a measurement display mode by no operating it for 10 seconds.</p>																	
<p>Display</p>	<p>• Setting of measurement display ON/OFF of an input 1.</p>																	

Note<sup>(24)</sup> This can be set during Wh measurement (display pattern D to J).

(9) Return to default setting (Setting No. 291)

Returns all settings to their default settings.

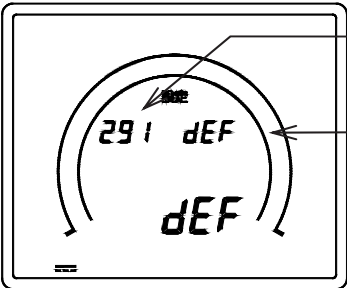
Setting process	<div style="text-align: center;"> <div style="border: 1px solid black; padding: 5px; width: fit-content; margin: 0 auto;">291 Default setting</div> <p style="text-align: center;">↓ Push SET for more than 3 seconds.</p> <div style="border: 1px solid black; padding: 5px; width: fit-content; margin: 0 auto;">Return to default setting</div> </div>		
Setting item	Setting No.	Contents of setting	Setting value possible range
	291	Return to default setting	—
Setting method	Setting display	If <b>SET</b> switch and <b>DISPLAY</b> switch are pressed together for longer than 3 seconds, it becomes the setting mode 2 from measurement display mode. For shifting to the item of "return to default setting", press <b>+</b> and <b>RESET/SHIFT</b> or <b>-</b> and <b>RESET/SHIFT</b> together.	
	Return to default setting	<b>SET</b> switches are pressed for longer than 3 seconds, all the set points return to a default setting.	
Reset method	Press the <b>DISPLAY</b> switch or returns to a measurement display mode by no operating it for 10 minutes.		
Display	<ul style="list-style-type: none"> <li>• Return to default setting</li> </ul> <div style="display: flex; align-items: center;">  <div style="margin-left: 20px;"> <p>Setting No.</p> <p>Lights when initialization is execute.</p> </div> </div>		

### 6.6 Integrated value (Wh) reset

An integrated power value is reset (zero clear) with the following process.  
The display and communication data are set to 0 after reset.

- ① Press **SET** switch and **DISPLAY** switch for 3 seconds or more simultaneously, and goes into the screen in the setting mode 2.
- ② Press **RESET/SHIFT** switch and the **-** switch simultaneously, and goes into the display screen of setting No.291.

Setting mode 2.

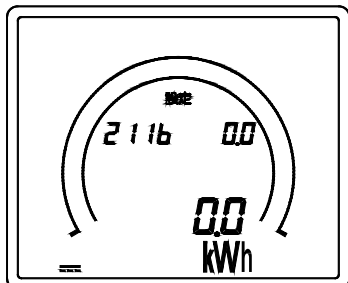

Setting No. 291

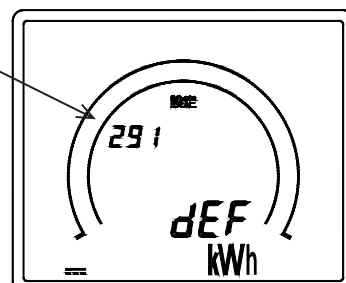

- ③ Press **+** switch and **-** switch for 5 seconds or more simultaneously, and indicates a "h.Clr".
- ④ If it returns from "h.Clr" display status to "dEF" display status, Wh integrated value reset is completion.

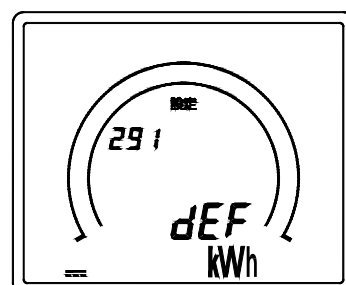
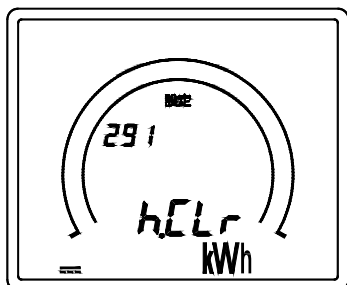

- ⑤ Presses the **DISPLAY** switch and returns to a measurement display mode.

### 6.7 About the scale of bar graph

- (1) Bar graph scale turns into nearest scale including the full-scale value of a display, it automatic-selects from the following standard scale, and displays.

And, a standard bar graph display becomes 3 kinds. (0 to N, -N to 0, -N to 0 to N)

Bar graph display of standard	At fragment swing	0 to N or -N to 0	$-9900 \leq N \leq 9900$
	At both swing	-N to 0 to N	

Example) Fragment swing

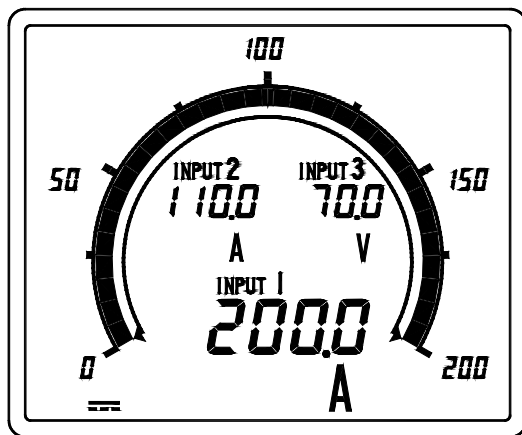

In case of display scaling setting 0 to 200.0A of input 1.

Example) Both swing

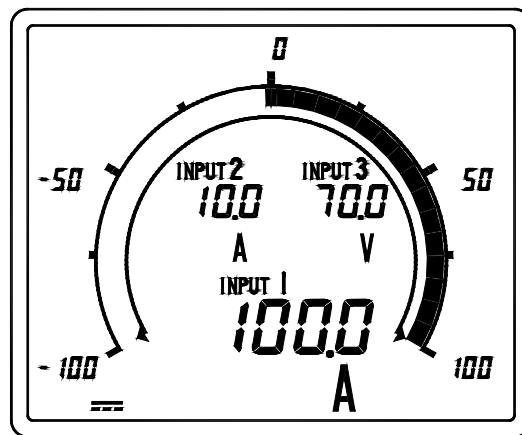

In case of display scaling setting -100.0 to 100.0A of input 1.

Standard scale	1, 1.2, 1.5, 1.6, 1.8, 2, 2.4, 2.5, 3, 3.2, 3.6, 4, 4.5, 4.8, 5, 6, 6.4, 7.2, 7.5, 8, 9, 9.6	Integral multiple of 10. (10 <sup>n</sup> )
----------------	--	---

- (2) In case a display full-scale value becomes between the above scale division by setting of a display scaling. The nearest bar graph scale including the value is selected.

Example) In case of display scaling setting 0 to 190.0A of input 1.

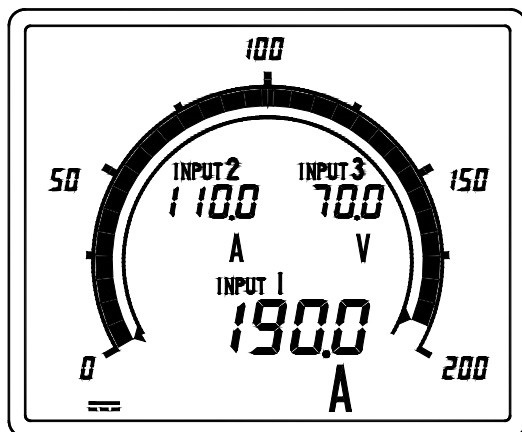

The scale of 200 is selected because there is no scale 190.

(The nearest bar scale including 190.0 values is selected.)

Example) In case of display scaling setting -98.0 to +98.0A of input 1.

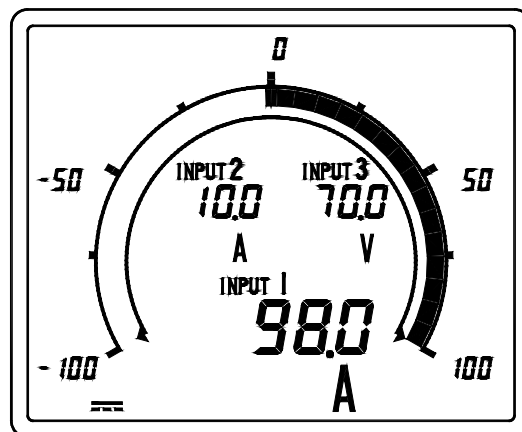

The scale of 100 is selected because there is no scale 98.

(The nearest bar scale including 98.0 values is selected.)

<Caution>

- In case of the scale which does not contain 0, such as 10 to 2000, display as the standard bar graph scale is 0 to 2000.
- In case of unbalanced scales, such as -10 to 0 to 100, display as the standard bar graph scale is -100 to 100.

- (3) Please refer to an attached chart 1 "Bar graph scale division details" about the details of each scale division.



## 7. Specification

## 7.1 Specification code, Type

① Type	② Hard model	③ Input 1	④ Input 2	⑤ Input 3	⑥ Auxiliary supply	⑦ External operation input	⑧ Analog output	⑨ Pulse output	⑩ Mounting position
-----------	-----------------	--------------	--------------	--------------	-----------------------	-------------------------------	--------------------	-------------------	------------------------

Product name		DC multi-meter							
① Type (Function)	Without backlight	TLC-110							
	With backlight	TLC-110L							
		DC input × 3 circuit (Max.)							
		Code							
② Hard model	A	Model A , Without backlight							
	D	Model D , With backlight (White)							
③ ④ ⑤ Input range ( ③ : Specification code for input 1 ④ : Specification code for input 2 ⑤ : Specification code for input 3 )	0	None							
	1	DC0 to 50mV							
	2	DC0 to 60mV							
	3	DC0 to 100mV							
	4	DC0 to 50V							
	5	DC0 to 75V							
	6	DC0 to 100V							
	7	DC0 to 150V							
	8	DC0 to 200V							
	9	DC0 to 1mA							
	W	DC power (W) measurement, DC integral power (Wh) measurement (Calculations value) <sup>(25)</sup>							
	Y	DC±301V to ±800V							
	Z	Other <sup>(26)</sup>							
	⑥ Auxiliary supply	1	AC85 to 253V DC80 to 143V for both AC and DC uses						
2		DC20 to 56V							
Z		Other							
⑦ External operation input	0	None							
	2	External reset							
	Z	Other							
⑧ Analog output	0	None							
	1	DC4 to 20mA							
	2	DC0 to 1mA							
	3	DC1 to 5V							
	4	DC0 to 5V							
	5	DC0 to 10V							
Z	Other <sup>(27)</sup>								
⑨ Pulse output	0	None							
	1	One output, Normally open contact (a contact) (Photo MOS relay)							
⑩ Mounting position (LCD view angle)	0	For upper installation (For lower view)							
	F	Wide viewing angle (Hard model D only)							

Note<sup>(25)</sup> In DC electric energy (Wh) measurement, please use it in scaling and unit of the appendix table 1 (power measurement scaling list).

Note<sup>(26)</sup> 1) Input range standard range ..... Voltage input : ±50mV to ±600V  
Current input : ±500 μA to ±50mA

2) Input range special range ..... Voltage input : ±601V to ±800V  
Current input : ±100 μA to ±499 μA  
(The digital display accuracy changes to ±1.0% → ±1.5%)

3) Voltage input more than ±301V. Used in combines series resistance (DM-1, accessories) with 1mA meter.

4) Current input over ±50mA. Used in combines a shunt (option).

Note<sup>(27)</sup> 1) Analog output standard range ... Voltage output : ±100mV to ±10V  
Current output : ±500 μA to +20mA, -10mA

2) Analog output special range ....  
1. In case all rating is not uniformity.  
2. Current output : ±100 μA to ±499 μA  
(The analog output accuracy changes to ±0.5% → ±1.0%)

## 7.2 Specification

Item	Specification				
Number of input circuits	Maximum of 3 circuit (Mutual insulates by AC2000V.)				
Input range	Code	Input	Input resistance	Remarks	
	0	No input	—		
	1	DC0 to 50mV	About 1M $\Omega$		Standard input range. Voltage input $\pm 50\text{mV}$ to $\pm 300\text{V}$ Current input $\pm 500\mu\text{A}$ to $\pm 50\text{mA}$
	2	DC0 to 60mV			
	3	DC0 to 100mV			Special input range. Voltage input $\pm 60\text{V}$ to $\pm 800\text{V}$ Current input $\pm 100\mu\text{A}$ to $\pm 499\mu\text{A}$ (The digital display accuracy changes to $\pm 1.0\%$ $\rightarrow$ $\pm 1.5\%$ .)
	4	DC0 to 50V			
	5	DC0 to 75V			
	6	DC0 to 100V			
	7	DC0 to 150V			Voltage input more than $\pm 30\text{V}$ , it is used combines a series resistance (DM-1, accessories) with 1mA meter.
	8	DC0 to 200V			
	9	DC0 to 1mA	About 1M $\Omega$		Current input over $\pm 50\text{mA}$ , it is used of combines a shunt (option).
Y	DC $\pm 30\text{V}$ to $\pm 800\text{V}$	About 301 to 800k $\Omega$			
Z	Other	—			
Maximum circuit voltage	500V (Standard)	However, it can respond to 800V by designation. (Withstand voltage for set to AC2000V $\rightarrow$ AC2200V.)			
Digital display range	Digital display	-9999 to 9999		Arbitrarily setting of the position of the number of digits and decimal point. <sup>(28)</sup>	
	Power factor (COS $\phi$ ) display	(1) LEAD 0.500 to 1.000 to LAG 0.500 (2) LEAD 0.000 to 1.000 to LAG 0.000		4 digits fixation. The position of decimal point is fixed.	
	Frequency display	(1) 45.0 to 55.0Hz or 45.00 to 55.00Hz (2) 55.0 to 65.0Hz or 55.00 to 65.00Hz (3) 45.0 to 65.0Hz or 45.00 to 65.00Hz		3 digits or 4 digits fixation. The position of decimal point is fixed.	
	Reactive power display (LEAD, LAG)	LEAD 9999 to 0 to LAG 9999		Arbitrarily setting of the position of the number of digits and decimal point.	
Bar graph display range	Maximum scale value	1, 1.2, 1.5, 1.6, 1.8, 2, 2.4, 2.5, 3, 3.2, 3.6, 4, 4.5, 4.8, 5, 6, 6.4, 7.2, 7.5, 8, 9, 9.6 Integral number times of 10. (10 <sup>n</sup> )		However range of $-9900 \leq N \leq 9900$	
	Power factor (COS $\phi$ ) display	(1) LEAD 0.5 to 1 to LAG 0.5 (2) LEAD 0 to 1 to LAG 0		A scale value is fixed. Only at the case of power-factor display selection, LEAD and LAG displays.	
	Frequency display	(1) 45 to 55Hz (2) 55 to 65Hz (3) 45 to 65Hz		A scale value is fixed.	
	Reactive power display (LEAD, LAG)	LEAD□ to 0 to LAG□ □ is the same numerical value as the above maximum scale.		However, the range of LEAD 9900 to 0 to LAG 9900. Only at the case of reactive power display selection, LEAD and LAG indicates.	

Note<sup>(28)</sup> If display 9999 is exceeded, the amount of DC powers (Wh) returns to 0, and continues a count.

Item	Specification									
	LCD (18 types) <sup>(29)</sup>		Unit lettering display (56 type) <sup>(31)</sup>							
Standard unit	(1)	A	(1)	APm	(19)	L/h	(37)	Nm <sup>3</sup> /min	(55)	度
	(2)	kA	(2)	bar	(20)	L/min	(38)	N/m <sup>2</sup>	(56)	kWh
	(3)	kV	(3)	cm	(21)	mA	(39)	N/mm <sup>2</sup>		
	(4)	kW <sup>(30)</sup>	(4)	COS $\phi$	(22)	mg/L	(40)	OPm		
	(5)	m	(5)	ELm	(23)	min <sup>-1</sup>	(41)	Pa		
	(6)	m/h <sup>(30)</sup>	(6)	Hz	(24)	mL/min	(42)	pH		
	(7)	m/min <sup>(30)</sup>	(7)	J	(25)	mm	(43)	ppm		
	(8)	min	(8)	K	(26)	m/h <sup>(32)</sup>	(44)	R		
	(9)	m <sup>3</sup>	(9)	kg	(27)	m/min <sup>(32)</sup>	(45)	rad		
	(10)	m <sup>3</sup> /h	(10)	kg/h	(28)	m/s	(46)	rpm		
	(11)	m <sup>3</sup> /min	(11)	kg/m <sup>2</sup>	(29)	MV	(47)	SPm		
	(12)	MW <sup>(30)</sup>	(12)	kg/m <sup>3</sup>	(30)	m <sup>3</sup> /s	(48)	t		
	(13)	r/min	(13)	kL	(31)	Mpa	(49)	t/h		
	(14)	V	(14)	kN	(32)	Mvar	(50)	TPm		
	(15)	W <sup>(30)</sup>	(15)	kPa	(33)	MW <sup>(32)</sup>	(51)	W <sup>(32)</sup>		
	(16)	%	(16)	kvar	(34)	N	(52)	YPm		
	(17)	°C	(17)	kW <sup>(32)</sup>	(35)	N•m	(53)	μm		
	(18)	No unit	(18)	L	(36)	Nm <sup>3</sup> /h	(54)	μS/cm		

Note<sup>(29)</sup> LCD, Main monitor : 18 types. Submonitor : 13 types.

Note<sup>(30)</sup> LCD display is possible only for the main monitor. Sub-monitor cannot display of LCD.

Note<sup>(31)</sup> Lettering display. Main monitor : 51 types, Sub-monitor : 56 types.

Lettering character height. Main monitor : 8.5mm, Sub-monitor : 5mm.

The character color of lettering, Gray (DIC, The 13th edition, 541)

Note<sup>(32)</sup> A lettering display is possible only for a sub-monitor.

The main monitor serves as a liquid crystal display.

## 7.3 Performance

Item		Specification		
Accuracy of digital display	INPUT1, 2, 3	$\pm 1.0\%$ (% for span)		
	A, V, W	$\pm 1.0\%$ (% for span)		
	Wh	$\pm 3.0\%$ <sup>(33)</sup> <sup>(34)</sup>		
Accuracy of digital display	$\pm 1.0\%$			
Accuracy of bar graph	$\pm 5.0\%$ (% for span)			
Influence of temperature	$23 \pm 10^\circ\text{C}$ in accuracy			
Conformity technical standard	JIS C 1102-1:1997 ... Direct acting indicating analogue electrical measuring instruments and their accessories. Part 1: Definitions and general requirements common to all parts.			
	JIS C 1102-2:1997 ... Direct acting indicating analogue electrical measuring instruments and their accessories. Part 2: Special requirements for ammeters and voltmeters.			
	JIS C 1102-7:1997 ... Direct acting indicating analogue electrical measuring instruments and their accessories. Part 7: Special requirements for multi-function instruments.			
	JIS C 1102-8:1997 ... Direct acting indicating analogue electrical measuring instruments and their accessories. Part 8: Special requirements for accessories.			
	JIS C 1102-9:1997 ... Direct acting indicating analogue electrical measuring instruments and their accessories. Part 9: Recommended test methods.			
	JIS C 1111:1989 ..... Electrical measuring transducers for converting a.c. electrical quantities into d.c. electrical quantities.			
	JIS C 1010-1:1998 ... Safety requirements for electrical equipment for measurement, control, and laboratory use. Part 1: General requirements.			
Display updating time	About 1 second (Bar graph of about 0.25 second)			
Display device, Display composition	LCD	Main monitor	Character height 10mm, 4 digits	
		Sub-monitor (Left), (Right)	Character height 6mm, 4 digits	
		Bar graph	30 dots	
Auxiliary supply	TLC-110 (Without backlight)	(1) AC85 to 253V 50/60Hz 10VA (Rated voltage AC100/110V, 200/220V) DC80 to 143V 5W (Rated voltage DC100/110V) for both AC and DC uses	(1) or (2). Designate	
		(2) DC20 to 56V 6W (Rated voltage DC24/48V)		
	TLC-110L (With backlight)	(1) AC85 to 253V 50/60Hz 12VA (Rated voltage AC100/110V, 200/220V) DC80 to 143V 6W (Rated voltage DC100/110V) for both AC and DC uses		
		(2) DC20 to 56V 7W (Rated voltage DC24/48V)		
	Rush current (Time constant)	Rated voltage AC110V Less than 5.2A (About 1.7ms)		
		Rated voltage AC220V Less than 10.4A (About 1.7ms)		
		Rated voltage DC110V Less than 3.7A (About 1.7ms)		
Rated voltage DC24V Less than 5.5A (About 3.6ms)				
Rated voltage DC48V Less than 10.9A (About 3.6ms)				
Overload capacity	Voltage circuit	2 times 10 seconds, 1.2 times continuation of rated voltage		
	Current circuit	10 times 5 seconds, 1.2 times continuation of rated current		
	Auxiliary supply	1.5 times 10 seconds, 1.2 times continuation of rated voltage. In case of DC110V, 1.5 times 10 seconds, 1.3 times continuation of rated voltage.		

Note<sup>(33)</sup> The starting current of the amount of direct current powers (Wh) becomes 2%. However, 2% or less, it performs measurement and performs a low input cut at less than 0.5% of W inputs. (The starting current is based on the differential meter assay inspection rule of Ministry of International Trade and Industry.)

Note<sup>(34)</sup> Power integrates only + power.

Item	Specification	
Insulation resistance	Between electric circuit and a case (ground).	Above 50M $\Omega$ at DC500V megger.
	Between input, output, auxiliary supply.	
	Between inputs.	
	Between outputs (analog, pulse).	
	Between analog outputs.	Non-insulation (Minus common)
Withstand voltage	Between electric circuit and a case (ground).	AC2000V (50/60Hz) 1 minute <sup>(35)</sup>
	Between input, output, auxiliary supply.	
	Between inputs.	AC1500V (50/60Hz) 1 minute
	Between outputs (analog, pulse).	Non-insulation (Minus common)
	Between analog outputs.	
Impulse withstand voltage	Between electric circuit and a case (ground).	5kV 1.2/50 $\mu$ s Both positive and negative polarity for 3 times each
Noise-capacity	<p>(1) Oscillatory surge voltage If a vibration damping waveform (1 to 1.5MHz, peak voltage : 2.5 to 3kV) is repeated and added, error is less than <math>\pm 10\%</math>. Voltage circuit, current circuit (Common) Auxiliary supply circuit (Normal / Common)</p> <p>(2) Square wave impulse noise If a noise (1<math>\mu</math>s, 100ns width) is repeated and it adds for 5 minutes, error is less than <math>\pm 10\%</math>. Voltage, current circuit (Common) Over 1.5kV Auxiliary supply circuit (Normal / Common) Over 1.5kV External operation input (Common) Over 1.0kV Analog output (Induction) Over 1.0kV Pulse output (Common) Over 1.0kV</p> <p>(3) Wave noise If the intermittence irradiation of the wave (5W, 1m) of 150MHz, 400MHz band is done, and if the intermittence irradiation of the wave (1m) of a cellular phone is done, error is less than <math>\pm 10\%</math>.</p> <p>(4) Electrostatic noise At the 8kV at power distribution, error is less than <math>\pm 10\%</math>. There needs to be no 10kV damage at the case of the non-power distribution. Condenser charge form.</p>	
Vibration, shock	Vibration : Single amplitude 0.15mm, 10 to 55Hz, Each minute octave in 5 times sweep Shock : 490m/s <sup>2</sup> Each direction 3 times	
Construction	Dimension : 110mm (Width) $\times$ 110mm (Height) $\times$ 104.5mm (Depth) Body diameter : 99mm $\phi$ With terminal cover	
Material	Case, Cover : ABS(V-0) , Terminal block : PBT , Terminal cover : Polycarbonate	
Color	Black (Munsell N1.5)	
Mass	Approx. 520g	
Warranty at blackout	Maximum value, Minimum value, Setting value. Nonvolatile memory in data holds.	
Operation temperature and humidity range	-10 to +55 $^{\circ}$ C, 30 to 85% RH Non condensing.	
Storage temperature range	-25 to +70 $^{\circ}$ C	

Note<sup>(35)</sup> In the case of circuit voltage 501 to 800V, the withstand voltage is AC2200V.

7.4 Option specifications [Production of the following products with input and output is possible by designating.]

Item	Specification																														
Analog output	Number of output circuits	Maximum of 3 circuit																													
	Rating	DC4 to 20mA (Below 550Ω) DC0 to 1mA (Below 10kΩ) DC1 to 5V (Over 600Ω)      Analog output designates either with rating of DC0 to 5V (Over 600Ω)      identification. <sup>(36)</sup> DC0 to 10V (Over 2kΩ) Other																													
	Accuracy	±0.5%																													
	Response time	Less than 1 second (The time that final steady value deliver to ±1%)																													
	Output ripple	For output span. Less than 1% P-P.																													
	Mutual output interval : Non-insulation. (Minus common)																														
	External operation input	Input factor	External reset ×1																												
Input specification		External reset : By applying a voltage signal from the outside, the maximum value and the minimum value are reset. An input is the same rating as an auxiliary power supply. (1) AC100/110V 0.4VA, AC200/220V 1.4VA, DC100/110V 0.4W for both AC and DC uses Contact capacity : About 3mA (AC, DC100/110V), About 6mA (AC200/220V) (2) DC24V 0.3W, DC48V 1.2W Contact capacity : About 10mA (DC24V), About 20mA (DC48V)																													
Pulse output	Output factor	DC electric energy (Wh)																													
	Accuracy	±3.0%																													
	Output method	Optical MOS-FET relay, 1a contact																													
	Contact capacity	AC·DC125V, 70mA (Resistance load, inductive load)																													
	Pulse width	250ms±10% By range setting, it may have been 100 to 130ms. <sup>(37)</sup>																													
	Setting of an output pulse unit is possible in the next range.																														
		<table border="1"> <thead> <tr> <th>Multiplying factor</th> <th colspan="4">Output pulse unit (kWh/pulse)</th> </tr> </thead> <tbody> <tr> <td>0.1</td> <td>1</td> <td>0.1</td> <td>0.01</td> <td>0.001</td> </tr> <tr> <td>1</td> <td>10</td> <td>1</td> <td>0.1</td> <td>0.01</td> </tr> <tr> <td>10</td> <td>100</td> <td>10</td> <td>1</td> <td>0.1</td> </tr> <tr> <td>100</td> <td>1000</td> <td>100</td> <td>10</td> <td>1</td> </tr> <tr> <td>1000</td> <td><sup>(38)</sup> 10000</td> <td>1000</td> <td>100</td> <td>10</td> </tr> </tbody> </table> (Example) ← If multiplying factor 1 is designation, the next setting is possible for an output pulse unit. 10, 1, 0.1, 0.01	Multiplying factor	Output pulse unit (kWh/pulse)				0.1	1	0.1	0.01	0.001	1	10	1	0.1	0.01	10	100	10	1	0.1	100	1000	100	10	1	1000	<sup>(38)</sup> 10000	1000	100
Multiplying factor	Output pulse unit (kWh/pulse)																														
0.1	1	0.1	0.01	0.001																											
1	10	1	0.1	0.01																											
10	100	10	1	0.1																											
100	1000	100	10	1																											
1000	<sup>(38)</sup> 10000	1000	100	10																											

- Note<sup>(36)</sup> 1) Analog output standard range ... Voltage output : ±100mV to ±10V  
 Current output : ±500μA to +20mA, -10mA  
 2) Analog output special range ... 1. In case all rating is not uniformity.  
 2. Current output : ±100μA to ±499μA  
 (The analog output accuracy changes to ±0.5%→±1.0%)

Note<sup>(37)</sup> In the case of setting as more than 1 pulse / second of the pulse cycle

$$\left( \text{in case of } \frac{V \times A \text{ (kW)}}{\text{Output pulse unit}} \geq 3600 \right).$$

The pulse width is 100 to 130 ms. If pulse width is 250ms, it applies the limiter of a pulse output by about 2Hz. And if pulse width is 100 to 130ms, it applies the limiter of a pulse output by about 4.5Hz. (0 < pulse output (Hz) ≤ 2Hz or 4.5Hz)

Note<sup>(38)</sup> As for the output pulse unit 10000, a display is 9999. (For 4 digits of displays)

● Caution on the use of external operation input (Option)

Power consumption of external operation input is 0.4VA at AC110V or 1.4VA at AC220V or 0.4W at DC110V.

When a relay or a switch is used for power feed, its minimum application load should be about 1mA.

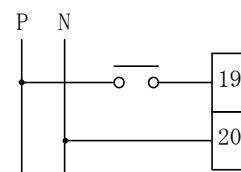

## 8. Trouble shooting

Symptoms	Possible causes	Remedial measures
Indicator does not display.	The power supply is not supplied. (Not connected. or voltage is low)	Check the auxiliary supply. Reapply of auxiliary power.
	Measurement display ON/OFF setting is set to OFF.	Please check setting
	Trouble of products.	Replace the products.
The error of measurement value is large.	Range setting is not right.	Please set again.
Analog output is not outputted.	Analog output is set to OFF or measurement display is set to OFF.	Please check setting

Attached chart 1.

Bar graph scale division details.

The number in a bar graph scale is equivalent to the number of the following figure liquid crystal screen.  
(A number is not displayed on actual liquid crystal.)

And, scale division changes with full-scale values.

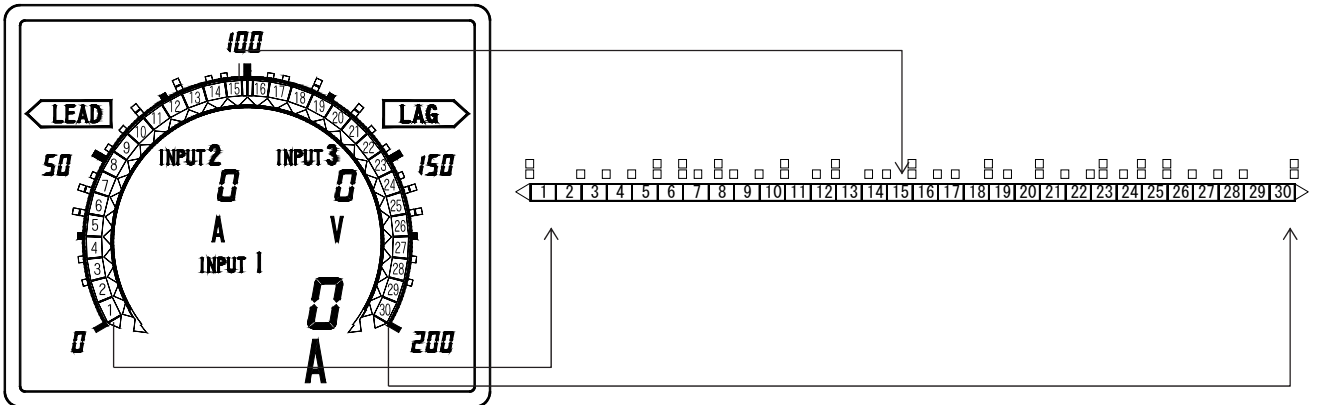

At fragment swing.

(0 to N)

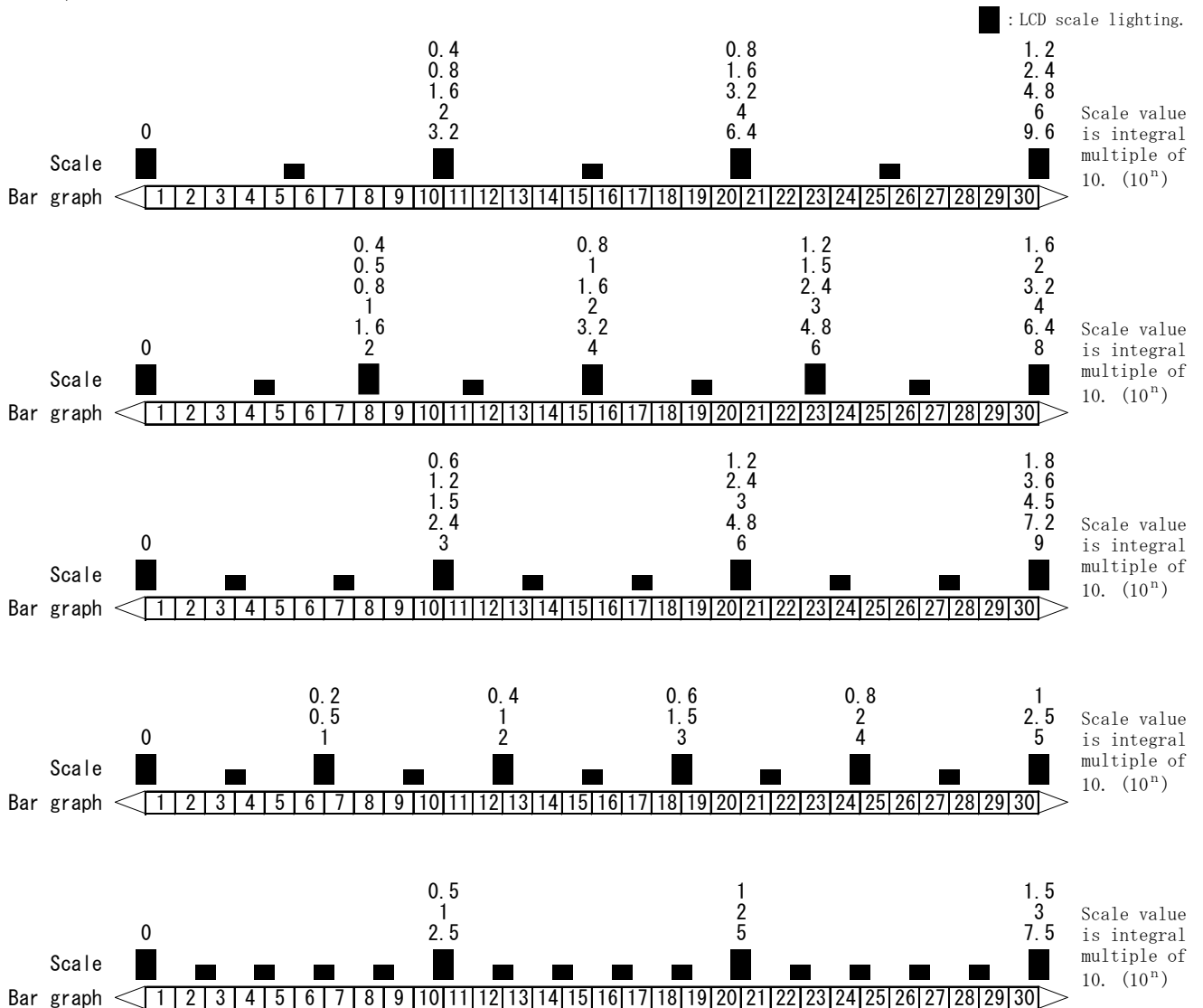



At fragment swing.  
(-N to 0)

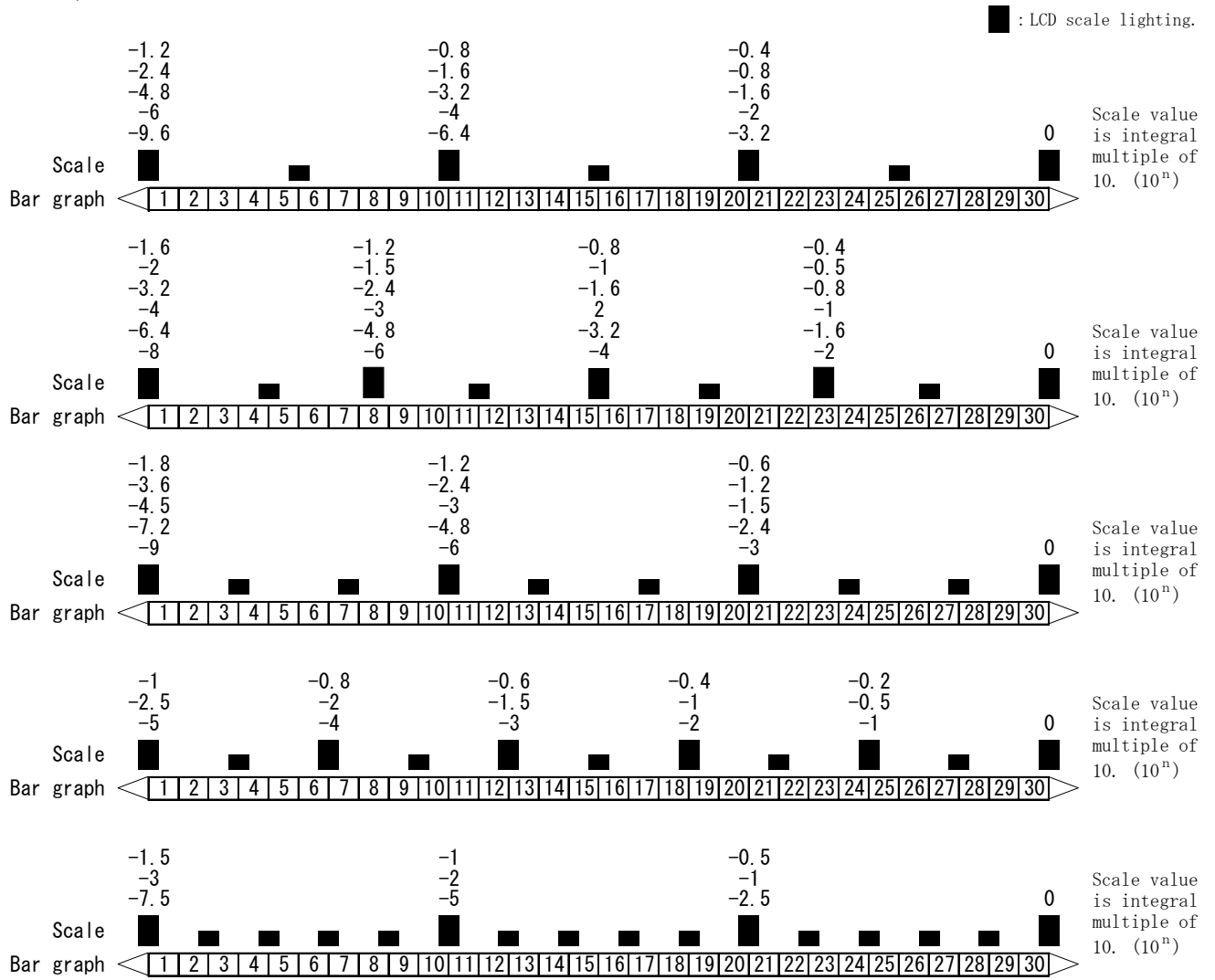

At both swing.  
(-N to 0 to N)

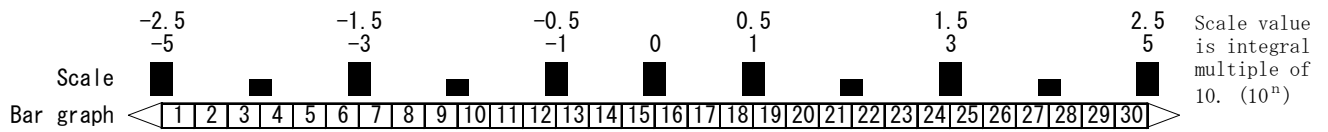
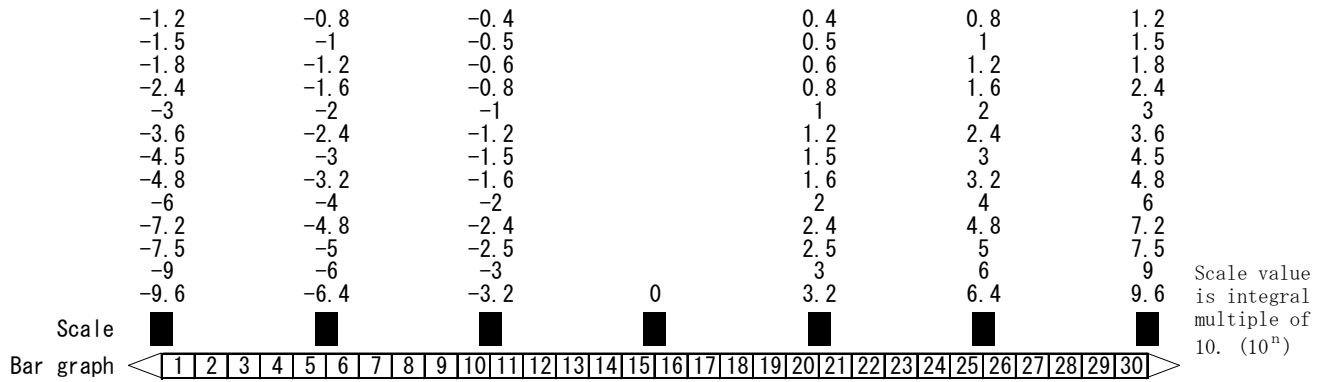
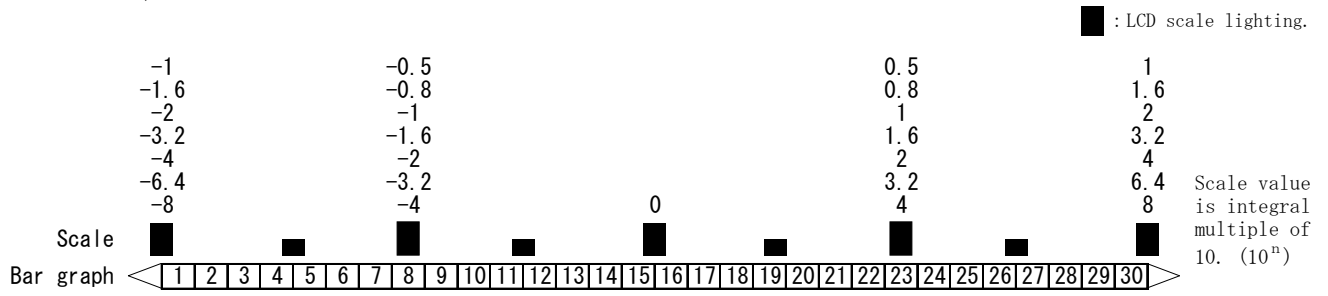

Frequency (Hz)

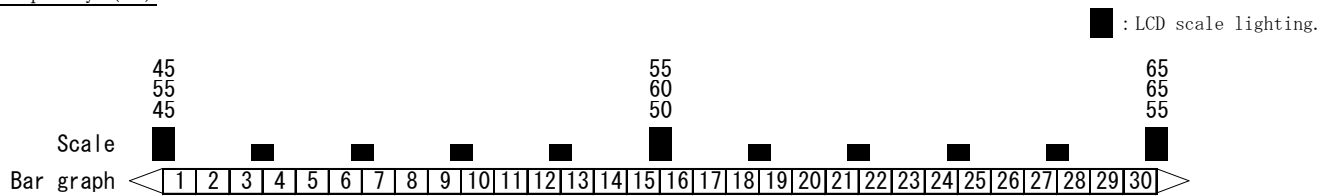

Power factor (COS $\phi$ )

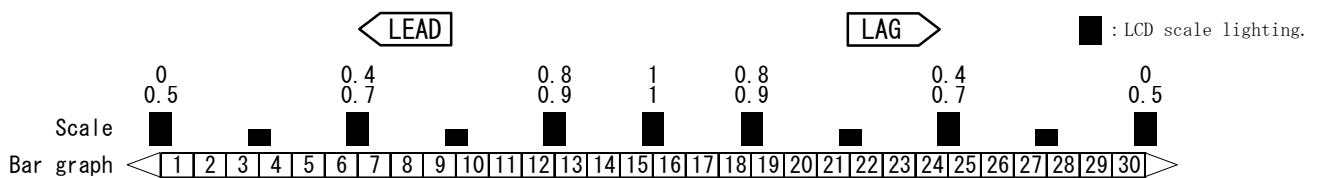

Reactive power (var)

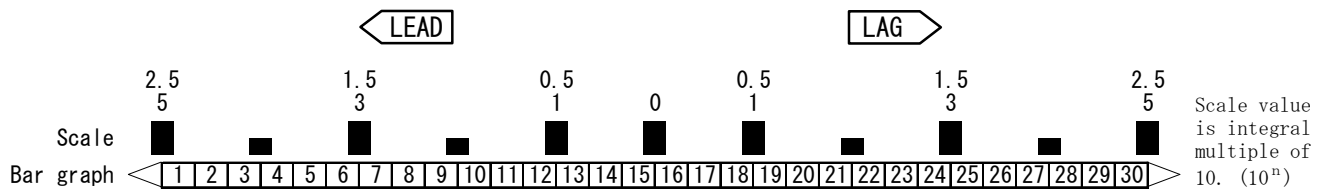
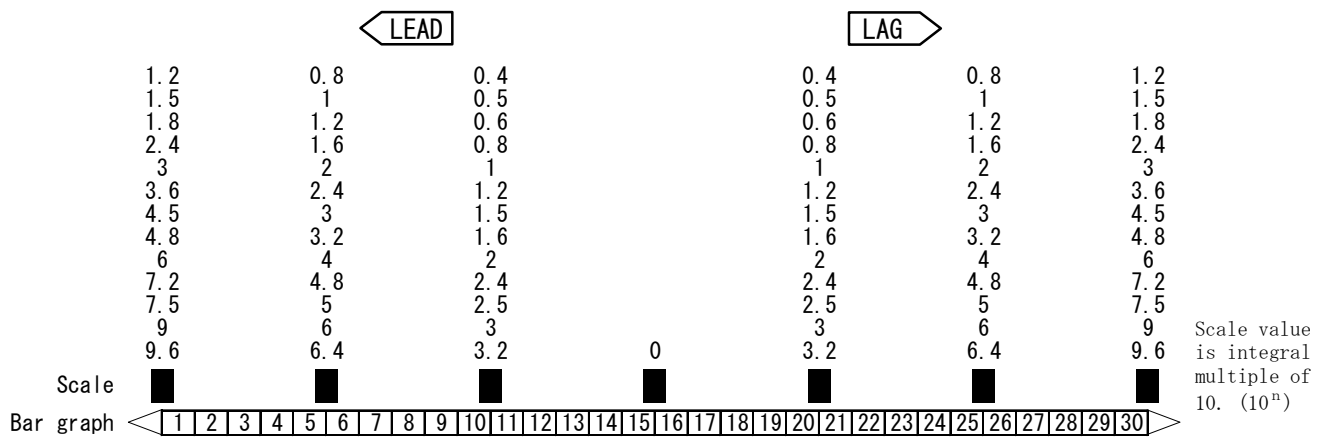
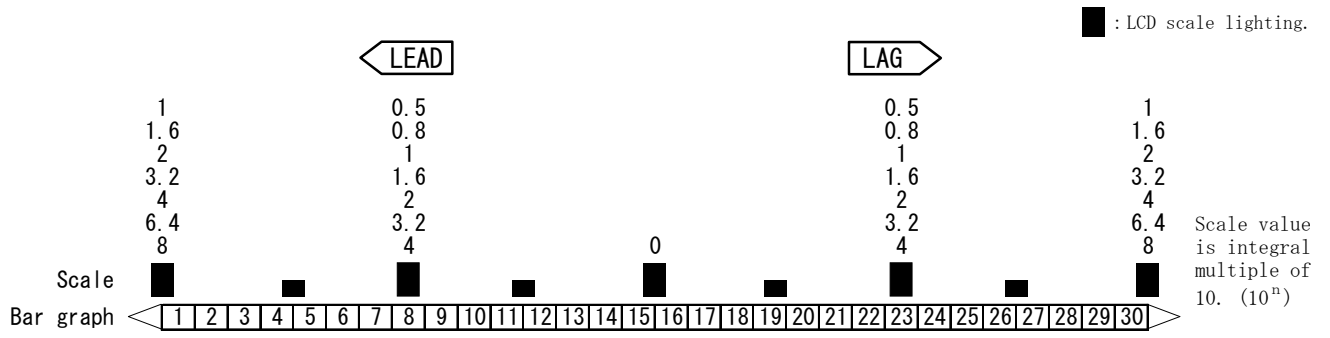

Appendix table 1

Power measurement scaling list. (The example of a display)

From a voltage value and current value, it does automatic scaling of the power value. And, the scaling change by manual operation is possible. In the case of the DC electric energy (Wh) measurement specification, it cannot use it other than the unit designated with the list.

	30V	50V	60V	75V	100V	150V	200V	250V	300V	400V	500V	600V	750V	800V
1A	30.00W (30)	50.0W (50)	60.0W (60)	75.0W (75)	100.0W (100)	150.0W (150)	200.0W (200)	250.0W (250)	300.0W (300)	400W (400)	500W (500)	600W (600)	750W (750)	800W (800)
1.2A	36.00W (36)	60.0W (60)	72.0W (72)	90.0W (90)	120.0W (120)	180.0W (180)	240.0W (240)	300.0W (300)	360.0W (360)	480W (480)	600W (600)	720W (720)	900W (900)	960W (960)
1.5A	45.0W (45)	75.0W (75)	90.0W (90)	112.5W (120)	150.0W (150)	225.0W (240)	300.0W (300)	375.0W (400)	450W (450)	600W (600)	750W (750)	900W (900)	1125W (1200)	1200W (1200)
2A	60.0W (60)	100.0W (100)	120.0W (120)	150.0W (150)	200.0W (200)	300.0W (300)	400W (400)	500W (500)	600W (600)	800W (800)	1000W (1000)	1200W (1200)	1500W (1500)	1600W (1600)
2.5A	75.0W (75)	125.0W (150)	150.0W (150)	187.5W (200)	250.0W (250)	375.0W (400)	500W (500)	625W (640)	750W (750)	1000W (1000)	1250W (1500)	1500W (1500)	1875W (2000)	2000W (2000)
3A	90.0W (90)	150.0W (150)	180.0W (180)	225.0W (240)	300.0W (300)	450W (450)	600W (600)	750W (750)	900W (900)	1200W (1200)	1500W (1500)	1800W (1800)	2250W (2400)	2400W (2400)
4A	120.0W (120)	200.0W (200)	240.0W (240)	300.0W (300)	400W (400)	600W (600)	800W (800)	1000W (1000)	1200W (1200)	1600W (1600)	2000W (2000)	2400W (2400)	3000W (3000)	3200W (3200)
5A	150.0W (150)	250.0W (250)	300.0W (300)	375.0W (400)	500W (500)	750W (750)	1000W (1000)	1250W (1500)	1500W (1500)	2000W (2000)	2500W (2500)	3000W (3000)	3750W (4000)	4.00kW (4)
6A	180.0W (180)	300.0W (300)	360.0W (360)	450W (450)	600W (600)	900W (900)	1200W (1200)	1500W (1500)	1800W (1800)	2400W (2400)	3000W (3000)	3600W (3600)	4.50kW (4.5)	4.80kW (4.8)
7.5A	225.0W (240)	375.0W (400)	450W (450)	563W (600)	750W (750)	1125W (1200)	1500W (1500)	1875W (2000)	2250W (2400)	3000W (3000)	3750W (4000)	4.50kW (4.5)	5.63kW (6)	6.00kW (6)
8A	240.0W (240)	400W (400)	480W (480)	600W (600)	800W (800)	1200W (1200)	1600W (1600)	2000W (2000)	2400W (2400)	3200W (3200)	4.00kW (4)	4.80kW (4.8)	6.00kW (6)	6.40kW (6.4)
10A	300.0W (300)	500W (500)	600W (600)	750W (750)	1000W (1000)	1500W (1500)	2000W (2000)	2500W (2500)	3000W (3000)	4.00kW (4)	5.00kW (5)	6.00kW (6)	7.50kW (7.5)	8.00kW (8)
12A	360.0W (360)	600W (600)	720W (720)	900W (900)	1200W (1200)	1800W (1800)	2400W (2400)	3000W (3000)	3600W (3600)	4.80kW (4.8)	6.00kW (6)	7.20kW (7.2)	9.00kW (9)	9.60kW (9.6)
15A	450W (450)	750W (750)	900W (900)	1125W (1200)	1500W (1500)	2250W (2400)	3000W (3000)	3750W (4000)	4.50kW (4.5)	6.00kW (6)	7.50kW (7.5)	9.00kW (9)	11.25kW (12)	12.00kW (12)
20A	600W (600)	1000W (1000)	1200W (1200)	1500W (1500)	2000W (2000)	3000W (3000)	4.00kW (4)	5.00kW (5)	6.00kW (6)	8.00kW (8)	10.00kW (10)	12.00kW (12)	15.00kW (15)	16.00kW (16)
25A	750W (750)	1250W (1500)	1500W (1500)	1875W (2000)	2500W (2500)	3750W (4000)	5.00kW (5)	6.25kW (6.4)	7.50kW (7.5)	10.00kW (10)	12.50kW (15)	15.00kW (15)	18.75kW (20)	20.00kW (20)
30A	900W (900)	1500W (1500)	1800W (1800)	2250W (2400)	3000W (3000)	4.50kW (4.5)	6.00kW (6)	7.50kW (7.5)	9.00kW (9)	12.00kW (12)	15.00kW (15)	18.00kW (18)	22.50kW (24)	24.00kW (24)
40A	1200W (1200)	2000W (2000)	2400W (2400)	3000W (3000)	4.00kW (4)	6.00kW (6)	8.00kW (8)	10.00kW (10)	12.00kW (12)	16.00kW (16)	20.00kW (20)	24.00kW (24)	30.00kW (30)	32.00kW (32)
50A	1500W (1500)	2500W (2500)	3000W (3000)	3750W (4000)	5.00kW (5)	7.50kW (7.5)	10.00kW (10)	12.50kW (15)	15.00kW (15)	20.00kW (20)	25.00kW (25)	30.00kW (30)	37.50kW (40)	40.0kW (40)
60A	1800W (1800)	3000W (3000)	3600W (3600)	4.50kW (4.5)	6.00kW (6)	9.00kW (9)	12.00kW (12)	15.00kW (15)	18.00kW (18)	24.00kW (24)	30.00kW (30)	36.00kW (36)	45.0kW (45)	48.0kW (48)
75A	2250W (2400)	3750W (4000)	4.50kW (4.5)	5.63kW (6)	7.50kW (7.5)	11.25kW (12)	15.00kW (15)	18.75kW (20)	22.50kW (24)	30.00kW (30)	37.50kW (40)	45.0kW (45)	56.3kW (60)	60.0kW (60)
80A	2400W (2400)	4.00kW (4)	4.80kW (4.8)	6.00kW (6)	8.00kW (8)	12.00kW (12)	16.00kW (16)	20.00kW (20)	24.00kW (24)	32.00kW (32)	40.0kW (40)	48.0kW (48)	60.0kW (60)	64.0kW (64)
100A	3000W (3000)	5.00kW (5)	6.00kW (6)	7.50kW (7.5)	10.00kW (10)	15.00kW (15)	20.00kW (20)	25.00kW (25)	30.00kW (30)	40.0kW (40)	50.0kW (50)	60.0kW (60)	75.0kW (75)	80.0kW (80)
120A	3600W (3600)	6.00kW (6)	7.20kW (7.2)	9.00kW (9)	12.00kW (12)	18.00kW (18)	24.00kW (24)	30.00kW (30)	36.00kW (36)	48.0kW (48)	60.0kW (60)	72.0kW (72)	90.0kW (90)	96.0kW (96)
150A	4.50kW (4.5)	7.50kW (7.5)	9.00kW (9)	11.25kW (12)	15.00kW (15)	22.50kW (24)	30.00kW (30)	37.50kW (40)	45.0kW (45)	60.0kW (60)	75.0kW (75)	90.0kW (90)	112.5kW (120)	120.0kW (120)
200A	6.00kW (6)	10.00kW (10)	12.00kW (12)	15.00kW (15)	20.00kW (20)	30.00kW (30)	40.0kW (40)	50.0kW (50)	60.0kW (60)	80.0kW (80)	100.0kW (100)	120.0kW (120)	150.0kW (150)	160.0kW (160)
250A	7.50kW (7.5)	12.50kW (15)	15.00kW (15)	18.75kW (20)	25.00kW (25)	37.50kW (40)	50.0kW (50)	62.5kW (64)	75.0kW (75)	100.0kW (100)	125.0kW (150)	150.0kW (150)	187.5kW (200)	200.0kW (200)

It is the full-scale value of a digital display. ( ) is the full-scale value of bar graph.

< Cautions > Full scale is less than 4000, displays by 4 digits. More than 4000, displays by 3 digits.

Example) 20kW → 20.00kW

48kW → 4.80kW

	30V	50V	60V	75V	100V	150V	200V	250V	300V	400V	500V	600V	750V	800V
300A	9.00kW (9)	15.00kW (15)	18.00kW (18)	22.50kW (24)	30.00kW (30)	45.0kW (45)	60.0kW (60)	75.0kW (75)	90.0kW (90)	120.0kW (120)	150.0kW (150)	180.0kW (180)	225.0kW (240)	240.0kW (240)
400A	12.00kW (12)	20.00kW (20)	24.00kW (24)	30.00kW (30)	40.0kW (40)	60.0kW (60)	80.0kW (80)	100.0kW (100)	120.0kW (120)	160.0kW (160)	200.0kW (200)	240.0kW (240)	300.0kW (300)	320.0kW (320)
500A	15.00kW (15)	25.00kW (25)	30.00kW (30)	37.50kW (40)	50.0kW (50)	75.0kW (75)	100.0kW (100)	125.0kW (150)	150.0kW (150)	200.0kW (200)	250.0kW (250)	300.0kW (300)	375.0kW (400)	400kW (400)
600A	18.00kW (18)	30.00kW (30)	36.00kW (36)	45.0kW (45)	60.0kW (60)	90.0kW (90)	120.0kW (120)	150.0kW (150)	180.0kW (180)	240.0kW (240)	300.0kW (300)	360.0kW (360)	450kW (450)	480kW (480)
750A	22.50kW (24)	37.50kW (40)	45.0kW (45)	56.3kW (60)	75.0kW (75)	112.5kW (120)	150.0kW (150)	187.5kW (200)	225.0kW (240)	300.0kW (300)	375.0kW (400)	450kW (450)	563kW (600)	600kW (600)
800A	24.00kW (24)	40.0kW (40)	48.0kW (48)	60.0kW (60)	80.0kW (80)	120.0kW (120)	160.0kW (160)	200.0kW (200)	240.0kW (240)	320.0kW (320)	400kW (400)	480kW (480)	600kW (600)	640kW (640)
1000A	30.00kW (30)	50.0kW (50)	60.0kW (60)	75.0kW (75)	100.0kW (100)	150.0kW (150)	200.0kW (200)	250.0kW (250)	300.0kW (300)	400kW (400)	500kW (500)	600kW (600)	750kW (750)	800kW (800)
1200A	36.00kW (36)	60.0kW (60)	72.0kW (72)	90.0kW (90)	120.0kW (120)	180.0kW (180)	240.0kW (240)	300.0kW (300)	360.0kW (360)	480kW (480)	600kW (600)	720kW (720)	900kW (900)	960kW (960)
1500A	45.0kW (45)	75.0kW (75)	90.0kW (90)	112.5kW (120)	150.0kW (150)	225.0kW (240)	300.0kW (300)	375.0kW (400)	450kW (450)	600kW (600)	750kW (750)	900kW (900)	1125kW (1200)	1200kW (1200)
2kA	60.0kW (60)	100.0kW (100)	120.0kW (120)	150.0kW (150)	200.0kW (200)	300.0kW (300)	400kW (400)	500kW (500)	600kW (600)	800kW (800)	1000kW (1000)	1200kW (1200)	1500kW (1500)	1600kW (1600)
2.5kA	75.0kW (75)	125.0kW (150)	150.0kW (150)	187.5kW (200)	250.0kW (250)	375.0kW (400)	500kW (500)	625kW (640)	750kW (750)	1000kW (1000)	1250kW (1500)	1500kW (1500)	1875kW (2000)	2000kW (2000)
3kA	90.0kW (90)	150.0kW (150)	180.0kW (180)	225.0kW (240)	300.0kW (300)	450kW (450)	600kW (600)	750kW (750)	900kW (900)	1200kW (1200)	1500kW (1500)	1800kW (1800)	2250kW (2400)	2400kW (2400)
4kA	120.0kW (120)	200.0kW (200)	240.0kW (240)	300.0kW (300)	400kW (400)	600kW (600)	800kW (800)	1000kW (1000)	1200kW (1200)	1600kW (1600)	2000kW (2000)	2400kW (2400)	3000kW (3000)	3200kW (3200)
5kA	150.0kW (150)	250.0kW (250)	300.0kW (300)	375.0kW (400)	500kW (500)	750kW (750)	1000kW (1000)	1250kW (1500)	1500kW (1500)	2000kW (2000)	2500kW (2500)	3000kW (3000)	3750kW (4000)	4.00MW (4)
6kA	180.0kW (180)	300.0kW (300)	360.0kW (360)	450kW (450)	600kW (600)	900kW (900)	1200kW (1200)	1500kW (1500)	1800kW (1800)	2400kW (2400)	3000kW (3000)	3600kW (3600)	4.50MW (4.5)	4.80MW (4.8)
7.5kA	225.0kW (240)	375.0kW (400)	450kW (450)	563kW (600)	750kW (750)	1125kW (1200)	1500kW (1500)	1875kW (2000)	2250kW (2400)	3000kW (3000)	3750kW (4000)	4.50MW (4.5)	5.63MW (6)	6.00MW (6)
8kA	240.0kW (240)	400kW (400)	480kW (480)	600kW (600)	800kW (800)	1200kW (1200)	1600kW (1600)	2000kW (2000)	2400kW (2400)	3200kW (3200)	4.00MW (4)	4.80MW (4.8)	6.00MW (6)	6.40MW (6.4)
10kA	300.0kW (300)	500kW (500)	600kW (600)	750kW (750)	1000kW (1000)	1500kW (1500)	2000kW (2000)	2500kW (2500)	3000kW (3000)	4.00MW (4)	5.00MW (5)	6.00MW (6)	7.50MW (7.5)	8.00MW (8)
12kA	360.0kW (360)	600kW (600)	720kW (720)	900kW (900)	1200kW (1200)	1800kW (1800)	2400kW (2400)	3000kW (3000)	3600kW (3600)	4.80MW (4.8)	6.00MW (6)	7.20MW (7.2)	9.00MW (9)	9.60MW (9.6)
15kA	450kW (450)	750kW (750)	900kW (900)	1125kW (1200)	1500kW (1500)	2250kW (2400)	3000kW (3000)	3750kW (4000)	4.50MW (4.5)	6.00MW (6)	7.50MW (7.5)	9.00MW (9)	11.25MW (12)	12.00MW (12)
20kA	600kW (600)	1000kW (1000)	1200kW (1200)	1500kW (1500)	2000kW (2000)	3000kW (3000)	4.00MW (4)	5.00MW (5)	6.00MW (6)	8.00MW (8)	10.00MW (10)	12.00MW (12)	15.00MW (15)	16.00MW (16)
25kA	750kW (750)	1250kW (1500)	1500kW (1500)	1875kW (2000)	2500kW (2500)	3750kW (4000)	5.00MW (5)	6.25MW (6.4)	7.50MW (7.5)	10.00MW (10)	12.50MW (15)	15.00MW (15)	18.75MW (20)	20.00MW (20)
30kA	900kW (900)	1500kW (1500)	1800kW (1800)	2250kW (2400)	3000kW (3000)	4.50MW (4.5)	6.00MW (6)	7.50MW (7.5)	9.00MW (9)	12.00MW (12)	15.00MW (15)	18.00MW (18)	22.50MW (24)	24.00MW (24)
40kA	1200kW (1200)	2000kW (2000)	2400kW (2400)	3000kW (3000)	4.00MW (4)	6.00MW (6)	8.00MW (8)	10.00MW (10)	12.00MW (12)	16.00MW (16)	20.00MW (20)	24.00MW (24)	30.00MW (30)	32.00MW (32)
50kA	1500kW (1500)	2500kW (2500)	3000kW (3000)	3750kW (4000)	5.00MW (5)	7.50MW (7.5)	10.00MW (10)	12.50MW (15)	15.00MW (15)	20.00MW (20)	25.00MW (25)	30.00MW (30)	37.50MW (40)	40.00MW (40)
60kA	1800kW (1800)	3000kW (3000)	3600kW (3600)	4.50MW (4.5)	6.00MW (6)	9.00MW (9)	12.00MW (12)	15.00MW (15)	18.00MW (18)	24.00MW (24)	30.00MW (30)	36.00MW (36)	45.00MW (45)	48.00MW (48)
75kA	2250kW (2400)	3750kW (4000)	4.50MW (4.5)	5.63MW (6)	7.50MW (7.5)	11.25MW (12)	15.00MW (15)	18.75MW (20)	22.50MW (24)	30.00MW (30)	37.50MW (40)	45.00MW (45)	56.3MW (60)	60.00MW (60)
80kA	2400kW (2400)	4.00MW (4)	4.80MW (4.8)	6.00MW (6)	8.00MW (8)	12.00MW (12)	16.00MW (16)	20.00MW (20)	24.00MW (24)	32.00MW (32)	40.00MW (40)	48.00MW (48)	60.00MW (60)	64.00MW (64)
100kA	3000kW (3000)	5.00MW (5)	6.00MW (6)	7.50MW (7.5)	10.00MW (10)	15.00MW (15)	20.00MW (20)	25.00MW (25)	30.00MW (30)	40.00MW (40)	50.00MW (50)	60.00MW (60)	75.00MW (75)	80.00MW (80)

It is the full-scale value of a digital display. ( ) is the full-scale value of bar graph.

< Cautions > Full scale is less than 4000, displays by 4 digits. More than 4000, displays by 3 digits.

Example) 20MW → 20.00MW

48MW → 4.80MW

 **DAIICHI ELECTRONICS CO., LTD.**

Head Office : 11-13 Hitotsuya 1-chome, Adachi-ku, Tokyo, 121-8639 Japan.  
Phone : 03-3885-2411 , Fax : 03-3858-3966

Kyoto Office : 1-19 Ichinobe-Nishikawahara, Jyoyou-shi, Kyoto, 610-0114 Japan.  
Phone : 0774-55-1391 , Fax : 0774-54-1353

DATE : June 1, 2020