

SFLC-110L

COMMUNICATION SPECIFICATION

(Modbus RTU mode protocol)

HARDWARE MODEL D

Content

1. Communication specification	2
2. Transmission and reception protocol	2
3. Calculation method of CRC-16	3
4. Communication process flow chart	4
5. SFLC communication specification terminal arrangement	4
6. Modbus protocol RTU mode	5
6.1 Function code	5
6.2 Abnormal response	5
6.3 Measurement range request	5
6.4 Setting value request	7
6.5 Status request	10
6.6 Model information request	11
6.7 Measurement value request	12
6.8 Maximum / minimum reset request	16
6.9 Loopback test	17

1. Communication specification

Item	Specification	Default setting
Standard	TIA-485-A (2003)	
Protocol	Modbus protocol RTU mode	---
	Function code : 03H, 04H, 06H, 08H	
Transmission system	Half-duplex two-wire system	---
Synchronous system	Asynchronous communication method	---
Transmission rate ⁽¹⁾	4800bps / 9600bps / 19200bps / 38400bps	9600bps
Modulation code	NRZ	---
Start bit	1 bit	---
Data length	8 bit	---
Parity ⁽¹⁾	NONE / Even number / Odd number	Even number
Stop bit ⁽¹⁾	1 bit / 2 bit	1 bit
Cable length	1000m (The total extension)	---
Address ⁽¹⁾	1 to 247 (Connection is possible to 31 sets.)	1
Error detection	CRC-16 ($X^{16} + X^{15} + X^2 + 1$)	---
Transmission character	Binary	---

Transmission data are sent out from a bit 0.

Note⁽¹⁾ A setting change is made with a front switch.

2. Transmission and reception protocol

(1) Usual request (Query)

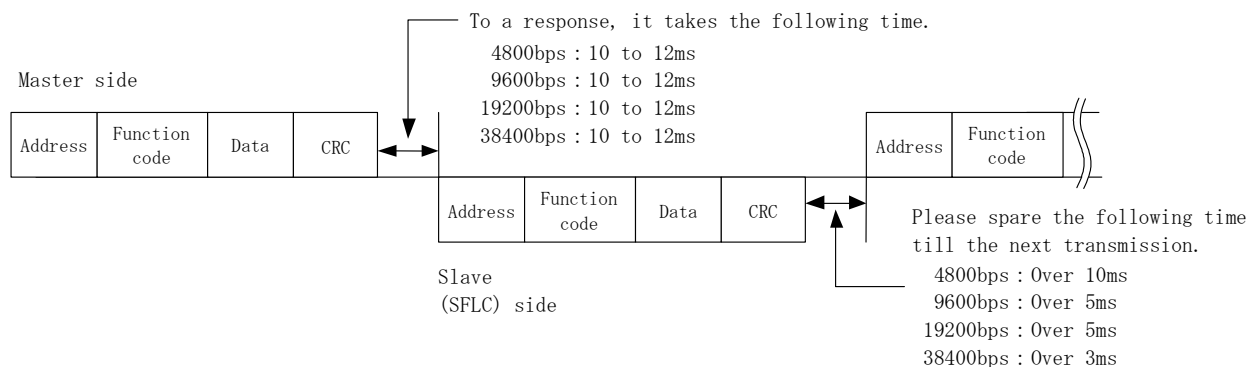

(2) Broadcast request (Query)

If all stations are specified in the address, it becomes a broadcast request. At this time, the slave side becomes unresponsive.

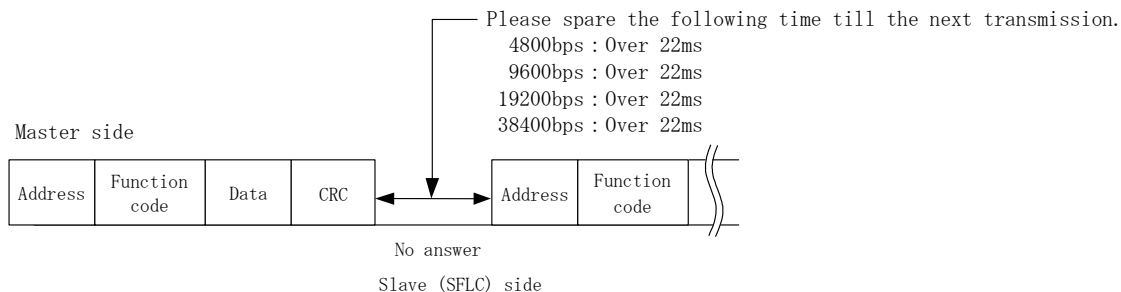

(3) The timeout between data

The interval between data must be 1.5 characters or less.

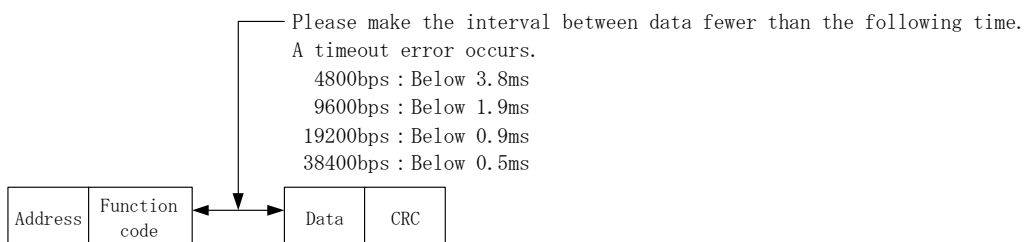

3. Calculation method of CRC-16

CRC-16 is adopted as error checking in Modbus RTU mode.

An address, a function code, and data are calculated by the following method.

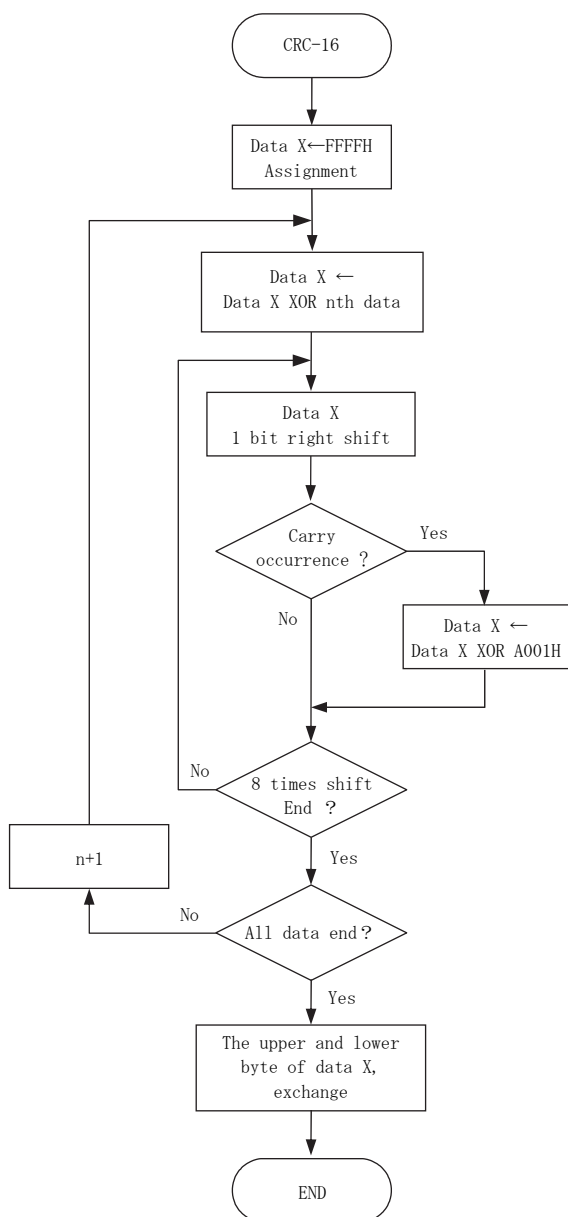

(1) Arithmetic process

- ① 2 bytes of data-area X is secured to a CRC calculation.
- ② FFFFH is substituted for ① as initial value.
- ③ XOR of data X and the nth data (n=1) is calculated. Assign it to data X.
- ④ The 1-bit right shift of the data X is done.
- ⑤ If carry occurs in operation of ④, data X and XOR of A001H are taken.
- ⑥ Operation of ④, ⑤ is repeated until it shifts 8 times.
- ⑦ The next data (n+1) and XOR of data X is calculated. Assign it to data X.
- ⑧ Operation of ④ to ⑦ is repeated until processing of all data is completed.
- ⑨ 1 byte of upper and 1 byte of lower of data-area X for a CRC calculation are exchanged.

(2) Example of calculation

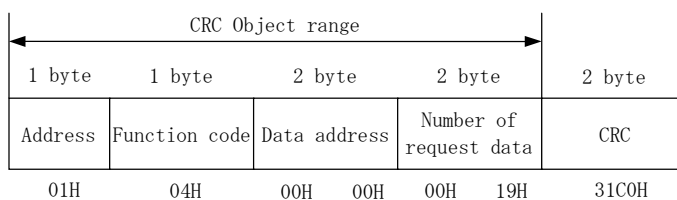

4. Communication process flow chart

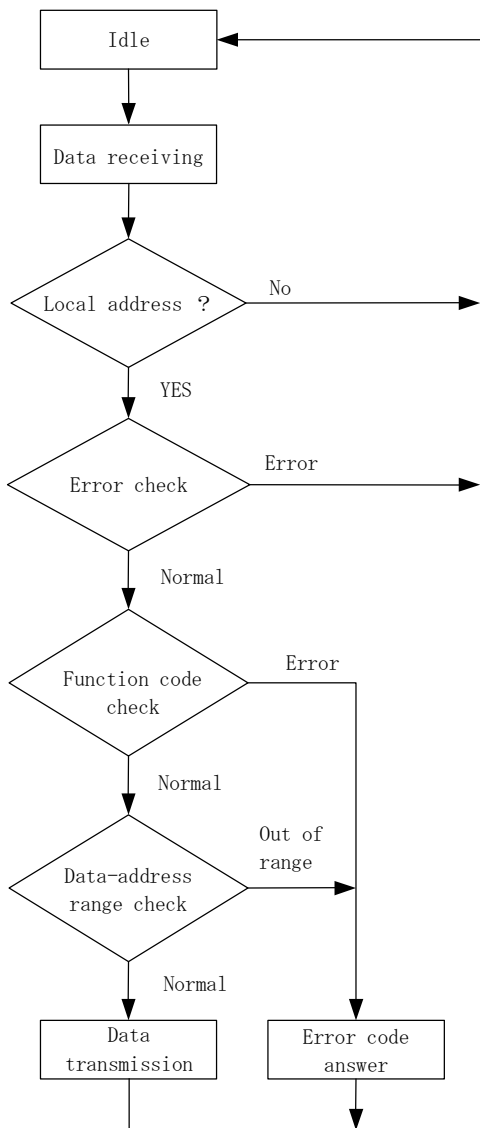

5. SFLC communication specification terminal arrangement

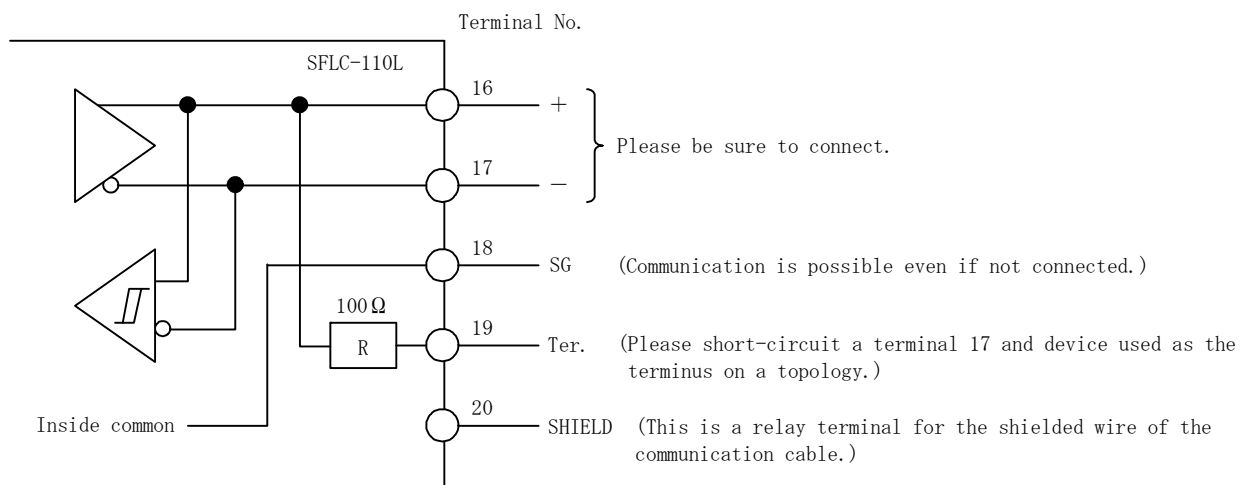

6. Modbus protocol RTU mode

6.1 Function code

The next function code is supported with this product.

Code	Name	Data address	Contents	Modbus original function
03	Measurement range request	40001 to	VT ratio, CT ratio and the readout of multiplying factor.	Holding register readout
	Setting value request	40101 to	The readout of setting value (measurement, alarm).	
	Status request	40201 to	The status readout of alarm output.	
	Model information request	40501 to	The readout of model information (type code, phase wire, rated voltage).	
04	Measurement value request	30001 to	The readout of measurement value (instant value / maximum value / minimum value).	Input-register readout
06	Maximum, Minimum reset	40301 to	Reset of the maximum value and the minimum value is performed.	Writing of simplex holding register
08	Loopback test	—	The communication test of master and slave is performed.	Diagnosis

6.2 Abnormal response

In case the message transmitted from the master is judged to be abnormal, this product does the next abnormal answer.

(1) In case it becomes a no answer

① : In case a message transmission error occurs. (Overrun, Framing, Parity error, CRC)

② : In case the data interval of a message exceeds a regulation value (1.5 characters).

③ : In case the message frame exceeding 8 bytes is received.

(2) In case as answered in an error code.

In the error that does not correspond to (1), the following abnormal response is returned.

At this case, the code that applied 80H to the code of a demand is returned to a function code.

And, the generated error code is returned as data.

Error code list

Error code	Contents	1 byte	1 byte	1 byte	2 byte
01H	The function code besides regulation is received.	Address	Function code (+80H)	Error code	CRC
02H	Data address is out of range.				
03H	The data more than the number of answer data are required. Setting out of setting range.				
		01H	84H	02H	C2C1H

6.3 Measurement range request

Used for reading measurement-range information, such as VT and CT ratio, in this product.

There is no broadcast. A function code designates 03H.

(1) Data request (Query)

In case it performs setting value request, it is necessary to designate the start address of data to acquire.

When a data address is transmitted, please subtract 40001 from the address in data-address list.

Please assign the number of requested data as the number of data.

1	2	3	4	5	6	7	8
Address	Function code	Data address		Number of data			CRC
01H	03H	0000H		0003H			05CBH

Data address list

Function code	Data address	Item
03H	40001	VT ratio
	40002	CT ratio
	40003	Multiplying factor

(2) Response

If range request is performed normally, the following response will be returned from this product side.

Example) Data address : 40001, Number of data : 3.

1	2	3	4	5	6	7	8	9	10	11
Address	Function code	Answer byte count	VT ratio		CT ratio		Multiplying factor		CRC	

● VT ratio, CT ratio

VT ratio data = Primary rated value \div 110V

CT ratio data = Primary rated value \div 5A \times 10

Primary rated (V)	Setting value data	Primary rated (A)	Setting value data	Primary rated (A)	Setting value data
110	0001H (1)	5	000AH (10)	1500	0BB8H (3000)
220	0002H (2)	6	000CH (12)	1600	0C80H (3200)
380 (2)	0003H (3)	7.5	000FH (15)	1800	0E10H (3600)
440	0004H (4)	8	0010H (16)	2000	0FA0H (4000)
460 (2)	0005H (5)	10	0014H (20)	2500	1388H (5000)
480 (2)	0006H (6)	12	0018H (24)	3000	1770H (6000)
880	0008H (8)	15	001EH (30)	4000	1F40H (8000)
1100	000AH (10)	20	0028H (40)	5000	2710H (10000)
1650	000FH (15)	25	0032H (50)	6000	2EE0H (12000)
2200	0014H (20)	30	003CH (60)	7500	3A98H (15000)
3300	001EH (30)	40	0050H (80)	8000	3E80H (16000)
6600	003CH (60)	50	0064H (100)	9000	4650H (18000)
11k	0064H (100)	60	0078H (120)	10000	4E20H (20000)
13.2k	0078H (120)	75	0096H (150)	12000	5DC0H (24000)
13.8k (2)	007DH (125)	80	00A0H (160)	15000	7530H (30000)
16.5k	0096H (150)	100	00C8H (200)	20000	9C40H (40000)
18.4k (2)	00A7H (167)	120	00F0H (240)	30000	EA60H (60000)
22k	00C8H (200)	150	012CH (300)		
33k	012CH (300)	200	0190H (400)		
66k	0258H (600)	250	01F4H (500)		
77k	02BCH (700)	300	0258H (600)		
110k	03E8H (1000)	400	0320H (800)		
132k	04B0H (1200)	500	03E8H (1000)		
154k	0578H (1400)	600	04B0H (1200)		
187k	06A4H (1700)	750	05DCH (1500)		
220k	07D0H (2000)	800	0640H (1600)		
275k	09C4H (2500)	900	0708H (1800)		
380k (2)	0D7FH (3455)	1000	07D0H (2000)		
550k	1388H (5000)	1200	0960H (2400)		

The number of () expresses decimal number data.

Note(2) Because broken numbers will occur if it divides by 110V, it becomes intrinsic set-value data.

● Multiplying factor

Multiplying factor	Communication data
$\times 0.01$	0005H (5)
$\times 0.1$	0006H (6)
$\times 1$	0000H (0)
$\times 10$	0001H (1)
$\times 100$	0002H (2)
$\times 1000$	0003H (3)
$\times 10000$	0004H (4)

The number of () expresses decimal number data.

6.4 Setting value request

Read the setting value (measurement, alarm) from this product. There is no broadcast. Function code is 03H.

(1) Data request (Query)

In case it performs setting value request, it is necessary to designate the start address of data to acquire. When a data address is transmitted, please subtract 40001 from the address in data-address list. Please assign the number of requested data as the number of data.

1	2	3	4	5	6	7	8
Address	Function code	Data address		Number of data		CRC	
01H	03H	0064H		000EH		85D1H	

Data address list

Function code	Data address	Item
03H	40101	Alarm output Output factor
	40102	0000H (Fixation)
	40103	Alarm output Reset method
	40104	Alarm output Contact delay time
	40105	0000H (Fixation)
	40106	Demand current Upper limit value
	40107	Demand current Time interval
	40108	Demand power Upper limit value
	40109	Demand power Time interval
	40110	Demand power Operation method
	40111	0000H (Fixation)
	40112	0000H (Fixation)
	40113	0000H (Fixation)
	40114	0000H (Fixation)
	40115	0000H (Fixation)
	40116	0000H (Fixation)
	40117	0000H (Fixation)
	40118	0000H (Fixation)
	40119	0000H (Fixation)
	40120	0000H (Fixation)
	40121	0000H (Fixation)
	40122	Instantaneous detection Voltage upper limit value
	40123	Instantaneous detection Voltage lower limit value
	40124	0000H (Fixation)
	40125	0000H (Fixation)
	40126	0000H (Fixation)
	40127	0000H (Fixation)
	40128	Tidal current measurement

(2) Response

If data request is performed normally, the following response will be returned from this product side.

Example) Data address : 40101, Number of data : 10.

1	2	3	4	5	6	7	8	9	10	11	12	13		
Address	Function code	Answer byte count	Alarm output output factor	0000H			Alarm output reset method	Alarm output contact delay time			0000H			
			14	15	16	17	18	19	20	21	22	23	24	25
			Demand current upper limit value		Demand current time interval		Demand power upper limit value		Demand power time interval		Demand power operation method		CRC	

● Setting value data

(1) Alarm output, output factor

Communication data	Contents of output
0000H	Alarm OFF
0001H	Demand current
0002H	Demand power
000AH	voltage

Those without an alarm output, "0000H" is returned.

(2) Alarm output reset method

B15	B14	B13	B12	B11	B10	B9	B8	B7	B6	B5	B4	B3	B2	B1	B0
—	—	—	—	—	—	—	—	—	—	—	—	—	—	—	①

No.	Reset factor
①	Alarm

0 : Auto reset
1 : Manual reset

Those without an alarm output, "0000H" is returned.

(3) Alarm output 1,2 contact delay time

Contact delay time (s) = Communication data

Contact delay time	Communication data
0 to 300s (1s step)	0000H to 012CH (0 to 300)

Those without an alarm output, "0000H" is returned.

(4) Demand current upper limit value

Demand current upper limit value = Communication data

Upper limit value	Communication data
5 to 100% (1% step), OFF	0005H to 0064H (5 to 100), OFF : 0065H (101)

(5) Demand current time interval

Demand current time interval = Communication data

Time interval	Communication data	Time interval	Communication data	Time interval	Communication data
0 second	0000H (0)	1 minute	003CH (60)	8 minutes	01E0H (480)
5 seconds	0005H (5)	2 minutes	0078H (120)	9 minutes	021CH (540)
10 seconds	000AH (10)	3 minutes	00B4H (180)	10 minutes	0258H (600)
20 seconds	0014H (20)	4 minutes	00F0H (240)	15 minutes	0384H (900)
30 seconds	001EH (30)	5 minutes	012CH (300)	20 minutes	04B0H (1200)
40 seconds	0028H (40)	6 minutes	0168H (360)	25 minutes	05DCH (1500)
50 seconds	0032H (50)	7 minutes	01A4H (420)	30 minutes	0708H (1800)

(6) Demand power upper limit value

Demand power upper limit value = Communication data

Upper limit value	Communication data
5 to 100% (1% step), OFF	0005H to 0064H (5 to 100), OFF : 0065H (101)

(7) Demand power time interval

Demand power time interval = Communication data

Time interval	Communication data	Time interval	Communication data	Time interval	Communication data
0 second	0000H (0)	1 minute	003CH (60)	8 minutes	01E0H (480)
5 seconds	0005H (5)	2 minutes	0078H (120)	9 minutes	021CH (540)
10 seconds	000AH (10)	3 minutes	00B4H (180)	10 minutes	0258H (600)
20 seconds	0014H (20)	4 minutes	00F0H (240)	15 minutes	0384H (900)
30 seconds	001EH (30)	5 minutes	012CH (300)	20 minutes	04B0H (1200)
40 seconds	0028H (40)	6 minutes	0168H (360)	25 minutes	05DCH (1500)
50 seconds	0032H (50)	7 minutes	01A4H (420)	30 minutes	0708H (1800)

(8) Demand power operation method

Operation method	Communication data
The operation method tailored to the bimetallic type	0001H
The averaging operator in a demand time interval	0002H

(9) Instantaneous detection voltage upper limit value

Voltage upper limit value = Communication data

upper limit value	Communication data
30 to 150% (1% step), OFF	001EH to 0096H (30 to 150), OFF : 0097H (151)

(10) Voltaeg lower limit value

Voltaeg lower limit value = Communication data

Lower limit value	Communication data
30 to 150% (1% step), OFF	001EH to 0096H (30 to 150), OFF : 001DH (29)

(11) Tidal current measurement

Measurement	Communication data
General measurement	0001H
Tidal current measurement	0002H

6.5 Status request

Used to read the instrument status. There is no broadcast. Function code is 03H.

(1) Data request (Query)

In case it performs setting value request, it is necessary to designate the start address of data to acquire. When a data address is transmitted, please subtract 40001 from the address in data-address list. Please assign the number of requested data as the number of data.

1	2	3	4	5	6	7	8
Address	Function code	Data address		Number of data		CRC	
01H	03H	00C8H		0001H		05F4H	

Data address list

Function code	Data address	Item
03H	40201	Status of alarm output

(2) Response

If status request is performed normally, the following response will be returned from this product side.

Example) Data address : 40201, Number of data : 1.

1	2	3	4	5	6	7
Address	Function code	Answer byte count	Alarm-output data		CRC	

● Bit allocation of alarm-output data

B15	B14	B13	B12	B11	B10	B9	B8	B7	B6	B5	B4	B3	B2	B1	B0
—	—	—	—	—	—	—	—	—	—	—	—	—	—	—	①

Bit	Name	OFF (0)	ON (1)
①	Alarm output	No detection	Detection

Those without an alarm output, "0000H" is returned.

6.6 Model information request

Used to read model information, rated voltage and rated current from this product.
There is no broadcast. Function code is 03H.

(1) Data request (Query)

In case it performs a model information request, it is necessary to designate the start address of data to acquire. When a data address is transmitted, please subtract 40001 from the address in data-address list. Please assign the number of requested data as the number of data.

1	2	3	4	5	6	7	8
Address	Function code	Data address		Number of data		CRC	
01H	03H	01F4H		0003H		45C5H	

Data address list

Function code	Data address	Item
03H	40501	Model information, Type code
	40502	Model information, Phase wire
	40503	Model information, Rated voltage

(2) Response

If model information request is performed normally, the following response will be returned from this product side.

Example) Data address : 40501, Number of data : 3.

1	2	3	4	5	6	7	8	9	10	11
Address	Function code	Answer byte count	Type code	Phase wire		Rated voltage		CRC		

● Model information. Type code

Type	Communication data
SFLC	0011H

● Model information. Phase wire

Type	Communication data
Three-phase three-wire	0001H
Single-phase three-wire (R-T-N)	0002H
Single-phase three-wire (R-S-N)	0003H
Single-phase three-wire (S-T-N)	0004H
Single-phase	0005H

● Model information. Rated voltage.

Rated voltage	Communication data
AC110V	0001H
AC220V	0002H

6.7 Measurement value request

Read the measurement value from this product. There is no broadcast. Function code is 04H.

(1) Data request (Query)

In case it performs setting value request, it is necessary to designate the start address of data to acquire. If a data address is transmitted, please subtract 30001 from the address in data-address list. Please assign the number of requested data as the number of data.

< Caution > Electric energy (Wh, varh) serves as 2 words (4 bytes) composition. Please give the number of data as 2. And, the point (data 0000H fixation) where a measurement value does not exist depending on a phase wire is also treated as one data.

1	2	3	4	5	6	7	8
Address	Function code	Data address		Number of data		CRC	
01H	04H	0000H		001DH		3003H	

Data-address list (1)

Function code	Data address	Model		
		3-phase 3-wire	Single-phase 3-wire	Single-phase
04	30001	0000H (Fixation)	0000H (Fixation)	0000H (Fixation)
04	30002	0000H (Fixation)	0000H (Fixation)	0000H (Fixation)
04	30003	0000H (Fixation)	0000H (Fixation)	0000H (Fixation)
04	30004	Voltage (RS)	Voltage (RN)	Voltage
04	30005	Voltage (ST)	Voltage (TN)	0000H (Fixation)
04	30006	Voltage (TR)	Voltage (RT)	0000H (Fixation)
04	30007	Current (R)	Current (R)	Current
04	30008	Current (S)	Current (N)	0000H (Fixation)
04	30009	Current (T)	Current (T)	0000H (Fixation)
04	30010	0000H (Fixation)	0000H (Fixation)	0000H (Fixation)
04	30011	Demand current (R)	Demand current (R)	Demand current
04	30012	Demand current (S)	Demand current (N)	0000H (Fixation)
04	30013	Demand current (T)	Demand current (T)	0000H (Fixation)
04	30014	0000H (Fixation)	0000H (Fixation)	0000H (Fixation)
04	30015	Active power	Active power	Active power
04	30016	Demand power	Demand power	Demand power
04	30017	Watt-hour (Power receiving) High	Watt-hour (Power receiving) High	Watt-hour (Power receiving) High
04	30018	Watt-hour (Power receiving) Low	Watt-hour (Power receiving) Low	Watt-hour (Power receiving) Low
04	30019	Watt-hour (Power transmission) High	Watt-hour (Power transmission) High	Watt-hour (Power transmission) High
04	30020	Watt-hour (Power transmission) Low	Watt-hour (Power transmission) Low	Watt-hour (Power transmission) Low
04	30021	Reactive power	Reactive power	Reactive power
04	30022	var-hour (Power receiving LAG) High	var-hour (Power receiving LAG) High	var-hour (Power receiving LAG) High
04	30023	var-hour (Power receiving LAG) Low	var-hour (Power receiving LAG) Low	var-hour (Power receiving LAG) Low
04	30024	var-hour (Power receiving LEAD) High	var-hour (Power receiving LEAD) High	var-hour (Power receiving LEAD) High
04	30025	var-hour (Power receiving LEAD) Low	var-hour (Power receiving LEAD) Low	var-hour (Power receiving LEAD) Low
04	30026	var-hour (Power transmission LAG) High	var-hour (Power transmission LAG) High	var-hour (Power transmission LAG) High

Data-address list (2)

Function code	Data address	Model		
		3-phase 3-wire	Single-phase 3-wire	Single-phase
04	30027	var-hour (Power transmission LAG) Low	var-hour (Power transmission LAG) Low	var-hour (Power transmission LAG) Low
04	30028	var-hour (Power transmission LEAD) High	var-hour (Power transmission LEAD) High	var-hour (Power transmission LEAD) High
04	30029	var-hour (Power transmission LEAD) Low	var-hour (Power transmission LEAD) Low	var-hour (Power transmission LEAD) Low
04	30030	0000H (Fixation)	0000H (Fixation)	0000H (Fixation)
04	30031	Power factor	Power factor	Power factor
04	30032	Frequency	Frequency	Frequency
04	30033	0000H (Fixation)	0000H (Fixation)	0000H (Fixation)
04	30034	0000H (Fixation)	0000H (Fixation)	0000H (Fixation)
04	30035	0000H (Fixation)	0000H (Fixation)	0000H (Fixation)
04	30036	0000H (Fixation)	0000H (Fixation)	0000H (Fixation)
04	30037	Maximum voltage (RS)	Maximum voltage (RN)	Maximum voltage
04	30038	Maximum voltage (ST)	Maximum voltage (TN)	0000H (Fixation)
04	30039	Maximum voltage (TR)	Maximum voltage (RT)	0000H (Fixation)
04	30040	0000H (Fixation)	0000H (Fixation)	0000H (Fixation)
04	30041	0000H (Fixation)	0000H (Fixation)	0000H (Fixation)
04	30042	0000H (Fixation)	0000H (Fixation)	0000H (Fixation)
04	30043	Minimum voltage (RS)	Minimum voltage (RN)	Minimum voltage
04	30044	Minimum voltage (ST)	Minimum voltage (TN)	0000H (Fixation)
04	30045	Minimum voltage (TR)	Minimum voltage (RT)	0000H (Fixation)
04	30046	Maximum current (R)	Maximum current (R)	Maximum current
04	30047	Maximum current (S)	Maximum current (N)	0000H (Fixation)
04	30048	Maximum current (T)	Maximum current (T)	0000H (Fixation)
04	30049	0000H (Fixation)	0000H (Fixation)	0000H (Fixation)
04	30050	Minimum current (R)	Minimum current (R)	Minimum current
04	30051	Minimum current (S)	Minimum current (N)	0000H (Fixation)
04	30052	Minimum current (T)	Minimum current (T)	0000H (Fixation)
04	30053	0000H (Fixation)	0000H (Fixation)	0000H (Fixation)
04	30054	Maximum demand current (R)	Maximum demand current (R)	Maximum demand current
04	30055	Maximum demand current (S)	Maximum demand current (N)	0000H (Fixation)
04	30056	Maximum demand current (T)	Maximum demand current (T)	0000H (Fixation)
04	30057	0000H (Fixation)	0000H (Fixation)	0000H (Fixation)
04	30058	Minimum demand current (R)	Minimum demand current (R)	Minimum demand current
04	30059	Minimum demand current (S)	Minimum demand current (N)	0000H (Fixation)
04	30060	Minimum demand current (T)	Minimum demand current (T)	0000H (Fixation)
04	30061	0000H (Fixation)	0000H (Fixation)	0000H (Fixation)
04	30062	Maximum power	Maximum power	Maximum power
04	30063	Minimum power	Minimum power	Minimum power
04	30064	Maximum demand power	Maximum demand power	Maximum demand power
04	30065	Minimum demand power	Minimum demand power	Minimum demand power
04	30066	Maximum reactive power	Maximum reactive power	Maximum reactive power
04	30067	Minimum reactive power	Minimum reactive power	Minimum reactive power
04	30068	0000H (Fixation)	0000H (Fixation)	0000H (Fixation)
04	30069	0000H (Fixation)	0000H (Fixation)	0000H (Fixation)
04	30070	Maximum power factor	Maximum power factor	Maximum power factor
04	30071	Minimum power factor	Minimum power factor	Minimum power factor
04	30072	Maximum frequency	Maximum frequency	Maximum frequency
04	30073	Minimum frequency	Minimum frequency	Minimum frequency
04	30074	0000H (Fixation)	0000H (Fixation)	0000H (Fixation)

(2) Response

If measurement value requirements are performed normally, the following response will be returned from this product side.

Example) Data address : 30001, Number of data : 29 (3-phase 3-wire)

1	2	3	4	5	6	7	8	9
Address	Function code	Answer byte count	00	00	00	00	00	00
10	11	12	13	14	15	16	17	
RS line voltage V(RS)	ST line voltage V(ST)	TR line voltage V(TR)	R phase current A(R)					
18	19	20	21	22	23	24	25	
S phase current A(S)	T phase current A(T)	00	00	R phase demand current DA(R)				
26	27	28	29	30	31	32	33	
S phase demand current DA(S)	T phase demand current DA(T)	00	00	Active power W				
34	35	36	37	38	39	40	41	
Demand power DW	Watt-hour (Power receiving) Wh High	Watt-hour (Power receiving) Wh Low	Watt-hour (Power transmission) -Wh High					
42	43	44	45	46	47	48	49	
Watt-hour (Power transmission) -Wh Low	Reactive power var	Reactive power (Power receiving, LAG) varh (LAG) High	Reactive power (Power receiving, LAG) varh (LAG) Low					
50	51	52	53	54	55	56	57	
Reactive power (Power receiving, LEAD) varh (LEAD) high	Reactive power (Power receiving, LEAD) varh (LEAD) Low	Reactive power (Power transmission, LAG) -varh (LAG) High	Reactive power (Power transmission, LAG) -varh (LAG) Low					
58	59	60	61	62	63			
Reactive power (Power transmission, LEAD) -varh (LEAD) High	Reactive power (Power transmission, LEAD) -varh (LEAD) Low	CRC						

Transmission scaling

Item		Input		Communication data ⁽³⁾	Intrinsic error
Voltage, Minimum voltage, Maximum voltage	3 φ 3W 1 φ 2W	AC0 to 150V, AC0 to 300V (Line)		0000H to 2710H (0 to 10000)	±0.5%
	1 φ 3W (⁴)	AC0 to 300V (Line)		0000H to 2710H (0 to 10000)	
		AC0 to 150V (Phase)	Phase-voltage full-scale 150V	0000H to 2710H (0 to 10000)	
			Phase-voltage full-scale 300V	0000H to 1388H (0 to 5000)	
Current, Minimum current, Maximum current, Minimum demand current, Maximum demand current, Demand current	AC0 to 5A		0000H to 2710H (0 to 10000)	±0.5%	
Active power, Minimum active power, Maximum active power, Maximum demand power, Minimum demand power, Demand power	3 φ 3W	110V	-1kW to 0 to +1kW	D8FOH to 0000H to 2710H (-10000 to 0 to +10000)	±0.5%
	1 φ 3W	220V	-2kW to 0 to +2kW		
	1 φ 2W	110V	-500W to 0 to +500W	EC78H to 0000H to 1388H (-5000 to 0 to +5000)	±0.5%
		220V	-1kW to 0 to +1kW		
Reactive power, Minimum reactive power, Maximum reactive power	3 φ 3W	110V	LEAD 1kvar to 0 to LAG 1kvar	D8FOH to 0000H to 2710H (-10000 to 0 to +10000)	±0.5%
	1 φ 3W	220V	LEAD 2kvar to 0 to LAG 2kvar		
	1 φ 2W	110V	LEAD 500var to 0 to LAG 500var	EC78H to 0000H to 1388H (-5000 to 0 to +5000)	±0.5%
		220V	LEAD 1kvar to 0 to LAG 1kvar		
Power factor, Minimum power factor, Maximum power factor	LEAD 0 to 1 to LAG 0		0000H to 1388H to 2710H (0 to 5000 to 10000)	±2.0%	
	LEAD 0.5 to 1 to LAG 0.5		09C4H to 1388H to 1D4CH (2500 to 5000 to 7500)		
Frequency, Minimum frequency, Maximum frequency	45 to 55Hz		1194H to 157CH (4500 to 5500)	±0.5%	
	55 to 65Hz		157CH to 1964H (5500 to 6500)		
	45 to 65Hz		1194H to 1964H (4500 to 6500)		
Watt-hour (Power receiving / Power transmission)	0 to 99999.9		00000000H to 000F423FH (0 to 999999) (⁵)	±2.0%	
var-hour (Power receiving / Power transmission, LAG/LEAD)	0 to 99999.9		00000000H to 000F423FH (0 to 999999) (⁵)	±2.5%	

Note⁽³⁾ The range of communication data, Data at the case of low input.

- Current : 120% rating [0000H to 2EE0H] (0 to 12000), Less than 0.5% of rated current is [0000H] (0).
- Demand current, maximum demand current : 200% rating [0000H to 4E20H] (0 to 20000), Less than 0.5% of rated current is [0000H] (0).
- Voltage : 101% full-scale [0000H to 2774H] (0 to 10100), the phase voltage at the case of single-phase three-wire phase voltage full-scale 300V setting is [0000H to 13BAH] (0 to 5050), Less than 0.5% of rated voltage is [0000H] (0).
- Active power, Reactive power : 120% rating [D120H to 2EE0H] (-12000 to 12000). At the case of single-phase is [E890H to 1770H] (-6000 to 6000). Less than ±0.5% of rated power and reactive power is [0000H] (0).
- Demand, maximum demand : ±200% rating [B1E0H to 4E20H] (-20000 to 20000), At the case of single-phase is [D8FOH to 2710H] (-10000 to 10000). Less than ±0.5% of rated power and reactive power is [0000H] (0).
- Power factor : Less than 20% of input voltage full-scale and less than 2% of rated current are [1388H] (5000).
- Frequency : ±1% of measuring range. 45 to 55Hz : 44.9 to 55.1Hz [118AH to 1586H] (4490 to 5510)
55 to 65Hz : 54.9 to 65.1Hz [1572H to 196EH] (5490 to 6510)
45 to 65Hz : 44.8 to 65.2Hz [1180H to 1978H] (4480 to 6520)
Less than 20% of voltage full-scale is [0000H].
- Active power, Reactive power : Minus data expresses with two's complement.
(-10000 to 0 to 10000 : D8FOH to 0000H to 2710H)

Note⁽⁴⁾ The default setting of phase-voltage full-scale setting is 300V.

Note⁽⁵⁾ By multiplying the electric energy data by the multiplier data, it becomes kWh (kvarh).

Example) Watt-hour (kWh) = Watt-hour data × Multiplying factor data = 123.4 × 100 = 12340kWh

6.8 Maximum / minimum reset request

Used to perform maximum / minimum reset for this product.

When 00H is specified for the address, there will be broadcast. Function code is 06H.

(1) Maximum / minimum reset request (Query)

When making a maximum / minimum reset request, it is necessary to send the write data including the data address and the element to be reset.

If a data address is transmitted, please subtract 40001 from the address in data-address list.

1	2	3	4	5	6	7	8
Address	Function code	Data address		Write data		CRC	
01H	06H	012CH		001FH		0837H	

Data address list

Function code	Data address	Item
06H	40301	Maximum, minimum reset

● Maximum minimum reset, Bit allocation of write data (6)

B15	B14	B13	B12	B11	B10	B9	B8	B7	B6	B5	B4	B3	B2	B1	B0
—	—	—	—	⑫	⑪	⑩	⑨	⑧	⑦	⑥	⑤	④	③	②	①

No.	Contents of output	No.	Contents of output
①	Voltage (Maximum, Minimum)	⑦	Frequency (Maximum, Minimum)
②	Current (Maximum, Minimum)	⑧	—
③	Active power (Maximum, Minimum)	⑨	Demand current (Maximum, Minimum)
④	Reactive power (Maximum, Minimum)	⑩	Demand power (Maximum, Minimum)
⑤	—	⑪	—
⑥	Power factor (Maximum, Minimum)	⑫	—

Note⁽⁶⁾ Except an applicable bit and the measurement factor that doesn't exist by the model, data is not reset as for ON (1).

(2) Response

If data change is performed normally, the following response will be returned from this product side.

If broadcast (address 00H) is specified, there is no response.

1	2	3	4	5	6	7	8
Address	Function code	Data address		Change data		CRC	

The same data as the write data of the maximum / minimum reset element is returned to the change data.

6.9 Loopback test

The loopback test is a function to test whether the master and slave (SFLC) are communicating normally. Arbitrary data is returned as it is. There is no broadcast. Function code is 08H.

(1) The request of loopback (Query)

When performing a loopback test, it is necessary to send data and diagnostic codes used for diagnosis. Specify 0000H as the diagnostic code. Specify any value from 0000H to FFFFH for the diagnostic data.

1	2	3	4	5	6	7	8
Address	Function code	Diagnostic code		Diagnostic data		CRC	
01H	08H	0000H		04D2H		6296H	

(2) Response

If loopback request is performed normally, the following response will be returned from this product side.

1	2	3	4	5	6	7	8
Address	Function code	Diagnostic code		Diagnostic data		CRC	

The same data sent by the master in (1) is returned as the diagnosis code and diagnostic data.

DAIICHI ELECTRONICS CO., LTD.

Tokyo Office : 11-13, Hitotsuya 1-chome, Adachi-ku, Tokyo, 121-8639, JAPAN.
TEL : +81-3-3885-2411 , Fax : +81-3-3858-3966

Kyoto Office : 1-19, Ichinobe-Nishikawahara, Jyoyou-shi, Kyoto, 610-0114, JAPAN.
TEL : +81-774-55-1391 , Fax : +81-774-54-1353

DATE : December 2, 2020